



中国认可
国际互认
检测
TESTING
CNAS L3110



TEST REPORT

Reference No. : WTF21D08089120W001
Manufacturer* : Mid Ocean Brands B.V.
Address : 7/F., Kings Tower, 111 King Lam Street, Cheung Sha Wan, Kowloon, Hong Kong
Factory : 110075
Product : TWS earbuds with charging base
Model(s) : MO9838
Standards : ETSI EN 300 328 V2.2.2 (2019-07)
Date of Receipt sample : 2021-09-07
Date of Test : 2021-09-07 to 2021-09-15
Date of Issue : 2021-09-30
Test Result : **Pass**

Remarks:

1. The results shown in this test report refer only to the sample(s) tested, this test report cannot be reproduced, except in full, without prior written permission of the company. The report would be invalid without specific stamp of test institute and the signatures of compiler and approver.
2. "*" **manufacturer** means any natural or legal person who manufactures radio equipment or has radio equipment designed or manufactured, and markets that equipment under his name or trade mark.

Prepared By:

Waltek Testing Group Co., Ltd.

Address: No. 77, Houjie Section, Guantai Road, Houjie Town, Dongguan City, Guangdong, China

Tel: +86-769-2267 6998

Fax: +86-769-2267 6828

Compiled by:

Approved by:

Andy Feng / Project Engineer

Ford Wang / Designated Reviewer



2 Contents

	Page
1 COVER PAGE	1
2 CONTENTS	2
3 REVISION HISTORY	3
4 GENERAL INFORMATION	4
4.1 GENERAL DESCRIPTION OF E.U.T.	4
4.2 DETAILS OF E.U.T.	4
4.3 CHANNEL LIST.....	5
4.4 ADDITIONAL INFORMATION.....	6
5 TEST SUMMARY	10
6 EQUIPMENT USED DURING TEST	11
6.1 EQUIPMENTS LIST	11
6.2 MEASUREMENT UNCERTAINTY	12
6.3 TEST EQUIPMENT CALIBRATION.....	12
7 RF REQUIREMENTS	13
7.1 RF OUTPUT POWER.....	14
7.2 ACCUMULATED TRANSMIT TIME, MINIMUM FREQUENCY OCCUPATION AND HOPPING SEQUENCE.....	18
7.3 HOPPING FREQUENCY SEPARATION	27
7.4 ADAPTIVITY (ADAPTIVE FREQUENCY HOPPING).....	33
7.5 RECEIVER BLOCKING	34
7.6 OCCUPIED CHANNEL BANDWIDTH.....	39
7.7 TRANSMITTER UNWANTED EMISSIONS IN THE OUT-OF-BAND DOMAIN.....	44
7.8 TRANSMITTER UNWANTED EMISSIONS IN THE SPURIOUS DOMAIN.....	49
7.9 RECEIVER SPURIOUS EMISSIONS.....	51
8 PHOTOGRAPHS OF TEST SETUP AND EUT	53



3 Revision History

Test report No.	Date of Receipt sample	Date of Test	Date of Issue	Purpose	Comment	Approved
WTF21D08089120 W001	2021-09-07	2021-09-07 to 2021-09-15	2021-09-30	Original	-	Valid

WALTEK



4 General Information

4.1 General Description of E.U.T.

Product:	TWS earbuds with charging base
Model(s):	MO9838
Model Description:	N/A
Bluetooth Version:	Bluetooth v5.0
Hardware Version	V1.1
Software Version	BAB5_NTC

4.2 Details of E.U.T.

Operation Frequency:	Bluetooth: 2402-2480MHz
Max. RF output power:	Basic Bluetooth: -0.47dBm
Type of Modulation:	Bluetooth: GFSK, Pi/4 DQPSK, 8DPSK
Antenna installation:	Bluetooth: internal permanent antenna
Antenna Gain:	Bluetooth: 0dBi
Ratings:	Input: charging base: 5V , 400mA (battery: 3.7V, 400mAh) Earbuds: 5V , 35mA (battery: 3.7V, 35mAh*2)

WALTEK



4.3 Channel List

BT mode

Channel No.	Frequency (MHz)	Channel No.	Frequency (MHz)	Channel No.	Frequency (MHz)	Channel No.	Frequency (MHz)
0	2402	1	2403	2	2404	3	2405
4	2406	5	2407	6	2408	7	2409
8	2410	9	2411	10	2412	11	2413
12	2414	13	2415	14	2416	15	2417
16	2418	17	2419	18	2420	19	2421
20	2422	21	2423	22	2424	23	2425
24	2426	25	2427	26	2428	27	2429
28	2430	29	2431	30	2432	31	2433
32	2434	33	2435	34	2436	35	2437
36	2438	37	2439	38	2440	39	2441
40	2442	41	2443	42	2444	43	2445
44	2446	45	2447	46	2448	47	2449
48	2450	49	2451	50	2452	51	2453
52	2454	53	2455	54	2456	55	2457
56	2458	57	2459	58	2460	59	2461
60	2462	61	2463	62	2464	63	2465
64	2466	65	2467	66	2468	67	2469
68	2470	69	2471	70	2472	71	2473
72	2474	73	2475	74	2476	75	2477
76	2478	77	2479	78	2480	-	-



4.4 Additional Information

a) The type of modulation used by the equipment:

- FHSS (for Basic Bluetooth)
- other forms of modulation (for BLE)

b) In case of FHSS modulation:

- In case of non-Adaptive Frequency Hopping equipment:
The number of Hopping Frequencies:
- In case of Adaptive Frequency Hopping Equipment:
The maximum number of Hopping Frequencies: 79
The minimum number of Hopping Frequencies: 79
The (average) Dwell Time: 336.4ms maximum

c) Adaptive / non-adaptive equipment:

- non-adaptive Equipment
- adaptive Equipment without the possibility to switch to a non-adaptive mode
- adaptive Equipment which can also operate in a non-adaptive mode

d) In case of adaptive equipment:

The Channel Occupancy Time implemented by the equipment: 916.4ms

- The equipment has implemented an LBT based DAA mechanism
- In case of equipment using modulation different from FHSS:
 - The equipment is Frame Based equipment
 - The equipment is Load Based equipment
 - The equipment can switch dynamically between Frame Based and Load Based equipment
 The CCA time implemented by the equipment: μ s
 The value q as referred to in clause 4.3.2.5.2.2.2
- The equipment has implemented a non-LBT based DAA mechanism
- The equipment can operate in more than one adaptive mode

Note: Since the EIRP less than 10dBm, so adaptive is not necessary.

e) In case of non-adaptive Equipment:

The maximum RF Output Power (e.i.r.p.): -0.47dBm
 The maximum (corresponding) Duty Cycle: %

Equipment with dynamic behaviour, that behaviour is described here. (e.g. the different combinations of duty cycle and corresponding power levels to be declared):

f) The worst case operational mode for each of the following tests:

- RF Output Power
Basic Bluetooth / BLE
- Power Spectral Density
GFSK For BLE
- Duty cycle, Tx-Sequence, Tx-gap
N/A
- Accumulated Transmit time, Minimum Frequency Occupation & Hopping Sequence (only for FHSS equipment)
Basic Bluetooth
- Hopping Frequency Separation (only for FHSS equipment)
Basic Bluetooth
- Medium Utilisation
N/A
- Adaptivity
N/A



- Receiver Blocking
Basic Bluetooth /BLE
- Occupied Channel Bandwidth
Basic Bluetooth /BLE
- Transmitter unwanted emissions in the OOB domain
Basic Bluetooth /BLE
- Transmitter unwanted emissions in the spurious domain
GFSK of of basic Bluetooth /BLE
- Receiver spurious emissions
GFSK of of basic Bluetooth/BLE

g) The different transmit operating modes (tick all that apply):

- Operating mode 1: Single Antenna Equipment
 - Equipment with only 1 antenna
 - Equipment with 2 diversity antennas but only 1 antenna active at any moment in time
 - Smart Antenna Systems with 2 or more antennas, but operating in a (legacy) mode where only 1 antenna is used. (e.g. IEEE 802.11™ [i.3] legacy mode in smart antenna systems)
- Operating mode 2: Smart Antenna Systems - Multiple Antennas without beam forming
 - Single spatial stream / Standard throughput / (e.g. IEEE 802.11™ [i.3] legacy mode)
 - High Throughput (> 1 spatial stream) using Occupied Channel Bandwidth 1
 - High Throughput (> 1 spatial stream) using Occupied Channel Bandwidth 2
 NOTE: Add more lines if more channel bandwidths are supported.
- Operating mode 3: Smart Antenna Systems - Multiple Antennas with beam forming
 - Single spatial stream / Standard throughput (e.g. IEEE 802.11™ [i.3] legacy mode)
 - High Throughput (> 1 spatial stream) using Occupied Channel Bandwidth 1
 - High Throughput (> 1 spatial stream) using Occupied Channel Bandwidth 2
 NOTE: Add more lines if more channel bandwidths are supported.

h) In case of Smart Antenna Systems:

- The number of Receive chains: N/A
- The number of Transmit chains: N/A
 - symmetrical power distribution
 - asymmetrical power distribution

In case of beam forming, the maximum beam forming gain: N/A

NOTE: Beam forming gain does not include the basic gain of a single antenna.

i) Operating Frequency Range(s) of the equipment:

- Operating Frequency Range 1: 2402 MHz to 2480 MHz
 - Operating Frequency Range 2: MHz to MHz
- NOTE: Add more lines if more Frequency Ranges are supported.

j) Occupied Channel Bandwidth(s):

- Occupied Channel Bandwidth 1: 0.867MHz
Occupied Channel Bandwidth 2: 1.188MHz
 - Occupied Channel Bandwidth 3: 1.171MHz
- NOTE: Add more lines if more channel bandwidths are supported.

k) Type of Equipment (stand-alone, combined, plug-in radio device, etc.):

- Stand-alone
- Combined Equipment (Equipment where the radio part is fully integrated within another type of equipment)
- Plug-in radio device (Equipment intended for a variety of host systems)

Other

l) The extreme operating conditions that apply to the equipment:

Normal operating conditions (if applicable):

Operating temperature: 25 °C

Waltek Testing Group Co., Ltd.

<http://www.waltek.com.cn>



Other (please specify if applicable):

Extreme operating conditions:

Operating temperature range: Minimum: -20 °C Maximum 40°C

Other (please specify if applicable): Minimum: Maximum

- Details provided are for the:
- stand-alone equipment
 - combined (or host) equipment
 - test jig

m) The intended combination(s) of the radio equipment power settings and one or more antenna assemblies and their corresponding e.i.r.p levels:

• Antenna Type

■ *Integral Antenna* Antenna Gain: 0dB

If applicable, additional beamforming gain (excluding basic antenna gain): dB

- Temporary RF connector provided
- No temporary RF connector provided
- Dedicated Antennas (equipment with antenna connector)
 - Single power level with corresponding antenna(s)
 - Multiple power settings and corresponding antenna(s)
 - Number of different Power Levels:
 - Power Level 1: dBm
 - Power Level 2: dBm

NOTE 1: Add more lines in case the equipment has more power levels.

NOTE 2: These power levels are conducted power levels (at antenna connector).

• For each of the Power Levels, provide the intended antenna assemblies, their corresponding gains (G) and the resulting e.i.r.p. levels also taking into account the beamforming gain (Y) if applicable

Power Level 1: dBm

Number of antenna assemblies provided for this power level:

Assembly #	Gain (dBi)	e.i.r.p. (dBm)	Part number or model name
1			
2			
3			
4			

n) The nominal voltages of the stand-alone radio equipment or the nominal voltages of the combined (host) equipment or test jig in case of plug-in devices:

- Details provided are for the:
- stand-alone equipment
 - combined (or host) equipment
 - test jig

Supply Voltage AC mains State AC voltage 100-240V

■ *DC State DC voltage :*

In case of DC, indicate the type of power source

- Internal Power Supply
- External Power Supply or AC/DC adapter
- *Battery: 3.7V*
- Other:*

o) Describe the test modes available which can facilitate testing:

The EUT can be into the Engineer mode for testing.

p) The equipment type (e.g. Bluetooth®, IEEE 802.11™ [i.3], proprietary, etc.):

Bluetooth

q) If applicable, the statistical analysis referred to in clause 5.3.1 q)

(to be provided as separate attachment)

r) If applicable, the statistical analysis referred to in clause 5.3.1 r)

(to be provided as separate attachment)

s) Geo-location capability supported by the equipment:

Waltek Testing Group Co., Ltd.

<http://www.waltek.com.cn>



Yes

The geographical location determined by the equipment as defined in clause 4.3.1.13.2 or clause 4.3.2.12.2 is not accessible to the user.

No

t) Describe the minimum performance criteria that apply to the equipment (see clause 4.3.1.12.3 or clause 4.3.2.11.3):

The minimum performance criterion shall be a PER less than or equal to 10 %.

WALTEK



5 Test Summary

RF PART		
Test Items	Test Requirement	Result
RF output power	ETSI EN 300 328	PASS
Duty Cycle, Tx-sequence, Tx-gap	ETSI EN 300 328	N/A
Accumulated Transmit Time, Frequency Occupation and Hopping Sequence	ETSI EN 300 328	PASS
Hopping Frequency Separation	ETSI EN 300 328	PASS
Medium Utilisation (MU) factor	ETSI EN 300 328	N/A
Adaptivity (Adaptive Frequency Hopping)	ETSI EN 300 328	N/A
Receiver Blocking	ETSI EN 300 328	PASS
Occupied Channel Bandwidth	ETSI EN 300 328	PASS
Maximum power spectral density	ETSI EN 300 328	N/A
Transmitter unwanted emissions in the out-of-band domain	ETSI EN 300 328	PASS
Transmitter unwanted emissions in the spurious domain	ETSI EN 300 328	PASS
Receiver spurious emissions	ETSI EN 300 328	PASS
Geo-location capability	ETSI EN 300 328	N/A
Remark: N/A: Not Applicable RF: In this whole report RF means Radio Frequency.		



6 Equipment Used during Test

6.1 Equipments List

Item	Equipment	Manufacturer	Model No.	Serial No.	Last Calibration Date	Calibration Due Date
1.	Spectrum Analyzer	Agilent	N9020A	MY49100060	2021-07-26	2022-07-25
2	EXA Signal Analyzer	Keysight	N9010A	MY50520207 526B25MPB W7X	2021-04-26	2022-04-25
3	ESG VECTOR SIGNAL GENERATOR	Keysight	E4438C	MY45092536	2021-04-26	2022-04-25
4	EXG Analog Signal Generator	Malaysia Keysight	N5171B	MY53050845	2021-07-26	2022-07-25
5	Trilog Broadband Antenna	SCHWARZBECK	VULB9163	336	2021-08-23	2022-08-22
6	Coaxial Cable (below 1GHz)	Top	TYPE16(13M)	-	2021-04-26	2022-04-25
7	Broad-band Horn Antenna	SCHWARZBECK	BBHA 9120 D	667	2021-04-30	2022-04-29
8	Broadband Preamplifier	COMPLIANCE DIRECTION	PAP-1G18	2004	2021-07-26	2022-07-25
9	Coaxial Cable (above 1GHz)	ZT26-NJ-NJ-8M/FA	1GHz-18GHz	NA	2021-04-26	2022-04-25
10	Broad-band Horn Antenna	SCHWARZBECK	BBHA 9170	335	2021-07-30	2022-07-29
11	Universal Radio Communication Tester	R&S	CMW500	116543	2021-07-26	2022-07-25

ETSI Test software

Software name	ETSI family
Software version	V2.2.2



6.2 Measurement Uncertainty

Parameter	Uncertainty
Occupied Channel Bandwidth	±5 %
RF output power, conducted	±0.42dB
Power Spectral Density, conducted	±0.7dB
Unwanted Emissions, conducted	±2.76dB
Time	±5%
Duty Cycle	±5%
Temperature	±1°C
Humidity	±2%
DC and low frequency voltages	±0.1%
Conduction disturbance(150kHz~30MHz)	±3.64dB
Radiated Emission(30MHz~1GHz)	±5.08dB
Radiated Emission(1GHz~6GHz)	±4.99dB

6.3 Test Equipment Calibration

All the test equipments used are valid and calibrated by CEPREI Certification Body that address is No.110 Dongguan Zhuang RD. Guangzhou, P.R.China.

WALTEK



7 RF Requirements

1. Normal Test Conditions:

Ambient Condition: 3.7VDC, 25 °C

2. Extreme Test Conditions:

Extreme Temperature: -20°C to 40°C;

For tests at extreme temperatures, measurements shall be made over the extremes of the operating temperature range as declared by the manufacturer.

Extreme Power Source Voltages: 3.3VDC to 4.1VDC

For tests at extreme voltages, measurements shall be made over the extremes of the power source voltage range as declared by the manufacturer.

Test Conditions	Normal	LTLV	LTHV	HTHV	HTLV
Temperature (°C)	25	-20	-20	40	40
Voltage (V)	3.7	3.3	4.1	4.1	3.3

3. Test Mode

All test mode(s) and condition(s) mentioned were considered and evaluated respectively by performing full tests, the worst data were recorded and reported.

For BT

Modulation	Test mode	Low channel	Middle channel	High channel
GFSK	Transmitting	2402MHz	2441MHz	2480MHz
GFSK	Receiving	2402MHz	2441MHz	2480MHz
Pi/4DQPSK	Transmitting	2402MHz	2441MHz	2480MHz
Pi/4DQPSK	Receiving	2402MHz	2441MHz	2480MHz
8DPSK	Transmitting	2402MHz	2441MHz	2480MHz
8DPSK	Receiving	2402MHz	2441MHz	2480MHz



7.1 RF Output power

7.1.1 Definition

The RF output power is defined as the mean equivalent isotropically radiated power (e.i.r.p.) of the equipment during a transmission burst.

7.1.2 Limit

The maximum RF output power for adaptive Frequency Hopping equipment shall be equal to or less than 20dBm.

The maximum RF output power for non-adaptive Frequency Hopping equipment, shall be declared by the supplier. See clause 5.4.1 m). The maximum RF output power for this equipment shall be equal to or less than the value declared by the manufacturer. This declared value shall be equal to or less than 20dBm.

This limit shall apply for any combination of power level and intended antenna assembly.

7.1.3 EUT Operation Condition

The EUT was programmed to be in continuously transmitting mode.

7.1.4 Test Procedure

Step 1:

- Use a fast power sensor suitable for 2.4 GHz and capable of minimum 1 MS/s.
- Use the following settings:
 - Sample speed 1 MS/s or faster.
 - The samples shall represent the RMS power of the signal.
 - Measurement duration: For non-adaptive equipment: equal to the observation period defined in clause 4.3.1.3.2 or clause 4.3.2.4.2. For adaptive equipment, the measurement duration shall be long enough to ensure a minimum number of bursts (at least 10) are captured.

NOTE 1: For adaptive equipment, to increase the measurement accuracy, a higher number of bursts may be used.

Step 2:

- For conducted measurements on devices with one transmit chain:
 - Connect the power sensor to the transmit port, sample the transmit signal and store the raw data. Use these stored samples in all following steps.
- For conducted measurements on devices with multiple transmit chains:
 - Connect one power sensor to each transmit port for a synchronous measurement on all transmit ports.
 - Trigger the power sensors so that they start sampling at the same time. Make sure the time difference between the samples of all sensors is less than 500 ns.
 - For each individual sampling point (time domain), sum the coincident power samples of all ports and store them. Use these summed samples in all following steps.

Step 3:

- Find the start and stop times of each burst in the stored measurement samples. The start and stop times are defined as the points where the power is at least 30 dB below the highest value of the stored samples in step 2.

NOTE 2: In case of insufficient dynamic range, the value of 30 dB may need to be reduced appropriately.

Step 4:



- Between the start and stop times of each individual burst calculate the RMS power over the burst using the formula below. Save these Pburst values, as well as the start and stop times for each burst.

$$P_{burst} = \frac{1}{k} \sum_{n=1}^k P_{sample}(n)$$

with 'k' being the total number of samples and 'n' the actual sample number

Step 5:

- The highest of all Pburst values (value "A" in dBm) will be used for maximum e.i.r.p. calculations.

Step 6:

- Add the (stated) antenna assembly gain "G" in dBi of the individual antenna.
- If applicable, add the additional beamforming gain "Y" in dB.
- If more than one antenna assembly is intended for this power setting, the maximum overall antenna gain (G or G + Y) shall be used.
- The RF Output Power (P) shall be calculated using the formula below:

$$P = A + G + Y$$

- This value, which shall comply with the limit given in clause 4.3.1.2.3 or clause 4.3.2.2.3, shall be recorded in the test report.

WALTEK



7.1.5 Measurement Record

Condition: Basic Bluetooth Mode

Modulation	Test conditions		EIRP (dBm)
			Frequencies Hopping Mode
GFSK	Normal		-0.50
	Extreme	LTLV	-0.53
		LTHV	-0.47
		HTLV	-0.55
		HTHV	-0.50
	Max. radiated Power		-0.47
Pi/4DQPSK	Normal		-1.59
	Extreme	LTLV	-1.61
		LTHV	-1.54
		HTLV	-1.64
		HTHV	-1.58
	Max. radiated Power		-1.54
8DPSK	Normal		-1.29
	Extreme	LTLV	-1.32
		LTHV	-1.24
		HTLV	-1.36
		HTHV	-1.29
	Max. radiated Power		-1.24
Limit		$\leq 100\text{mW (20dBm)}$	
Remark: $P = A + G + Y, G = -0\text{dBi}, Y = 0$			



Test Plots

GFSK

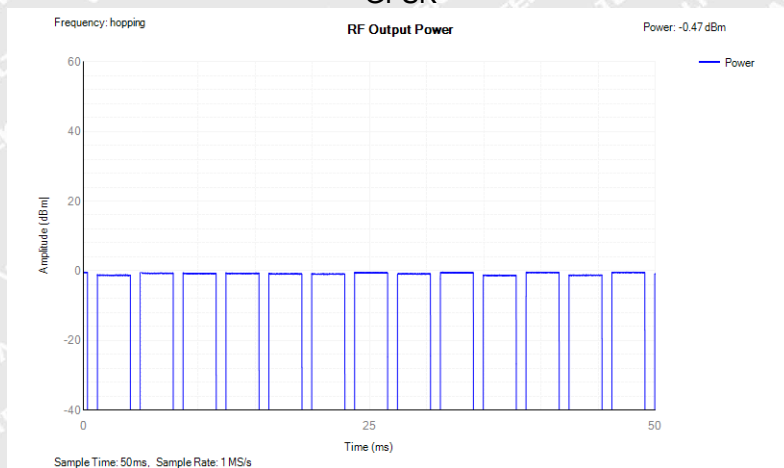

Pi/4DQPSK

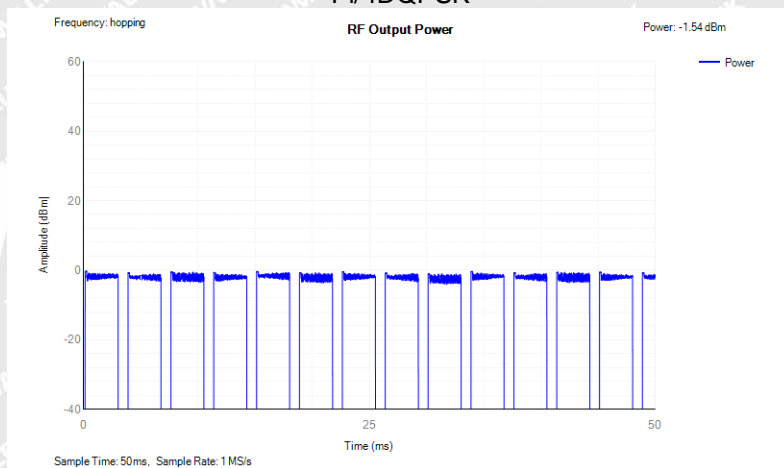

8DPSK

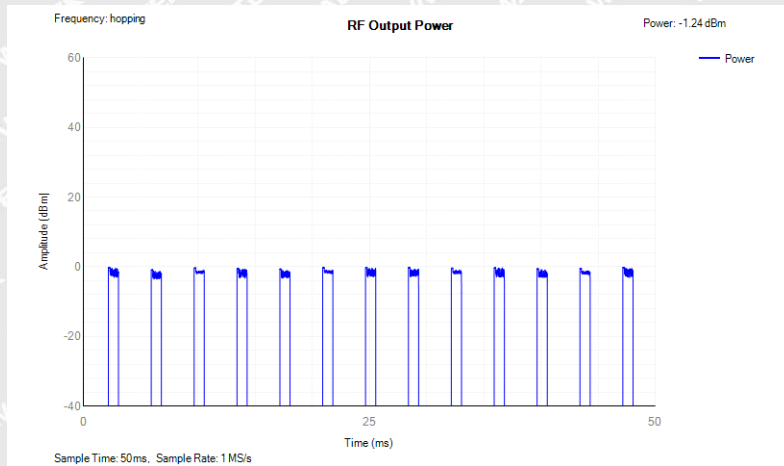



7.2 Accumulated Transmit Time, Minimum Frequency Occupation and Hopping Sequence

7.2.1 Definition

The Accumulated Transmit Time is the total of the transmitter 'on' times, during an observation period, on a particular hopping frequency.

The Frequency Occupation is the number of times that each hopping frequency is occupied within a given period. A hopping frequency is considered to be occupied when the equipment selects that frequency from the hopping sequence. The equipment may be transmitting, receiving or stay idle during the Dwell Time spent on that hopping frequency.

The Hopping Sequence of a frequency hopping equipment is the unrepeated pattern of the hopping frequencies used by the equipment.

7.2.2 Limit

Adaptive Frequency Hopping equipment shall be capable of operating over a minimum of 70 % of the band specified in clause 1.

The Accumulated Transmit Time on any hopping frequency shall not be greater than 400 ms within any observation period of 400 ms multiplied by the minimum number of hopping frequencies (N) that have to be used. In order for the equipment to comply with the Frequency Occupation requirement, it shall meet either of the following two options:

Option 1: Each hopping frequency of the hopping sequence shall be occupied at least once within a period not exceeding four times the product of the dwell time and the number of hopping frequencies in use.

Option 2: The occupation probability for each frequency shall be between $((1 / U) \times 25 \%)$ and 77 % where U is the number of hopping frequencies in use.

The hopping sequence(s) shall contain at least N hopping frequencies at all times, where N is 15 or 15 divided by the minimum Hopping Frequency Separation in MHz, whichever is the greater.

7.2.3 EUT Operation Condition

The equipment shall be configured to operate at its maximum Dwell Time and maximum Duty Cycle.

7.2.4 Test Procedure

Step 1:

- The output of the transmitter shall be connected to a spectrum analyzer or equivalent.
- The analyzer shall be set as follows:
 - Centre Frequency: Equal to the hopping frequency being investigated
 - Frequency Span: 0 Hz
 - RBW: ~ 50 % of the Occupied Channel Bandwidth
 - VBW: \geq RBW
 - Detector Mode: RMS
 - Sweep time: Equal to the applicable observation period (see clause 4.3.1.4.3.1 or clause 4.3.1.4.3.2)
 - Number of sweep points: 30 000
 - Trace mode: Clear / Write
 - Trigger: Free Run

**Step 2:**

- Save the trace data to a file for further analysis by a computing device using an appropriate software application or program.

Step 3:

- Identify the data points related to the frequency being investigated by applying a threshold.

The data points resulting from transmissions on the hopping frequency being investigated are assumed to have much higher levels compared to data points resulting from transmissions on adjacent hopping frequencies. If a

clear determination between these transmissions is not possible, the RBW in step 1 shall be further reduced. In addition, a channel filter may be used.

- Count the number of data points identified as resulting from transmissions on the frequency being investigated and multiply this number by the time difference between two consecutive data points.

Step 4:

- The result in step 3 is the Accumulated Transmit Time which shall comply with the limit provided in clause 4.3.1.4.3.1 or clause 4.3.1.4.3.2 and which shall be recorded in the test report.

Step 5:

NOTE 1: This step is only applicable for equipment implementing Option 1 in clause 4.3.1.4.3.1 or clause 4.3.1.4.3.2 for complying with the Frequency Occupation requirement and the manufacturer decides to demonstrate compliance with this requirement via measurement.

- Make the following changes on the analyser and repeat step 2 and step 3.

Sweep time: $4 \times \text{Dwell Time} \times \text{Actual number of hopping frequencies in use}$

The hopping frequencies occupied by the equipment without having transmissions during the dwell time (blacklisted frequencies) should be taken into account in the actual number of hopping frequencies in use. If this number cannot be determined (number of blacklisted frequencies unknown) it shall be assumed that the equipment uses the maximum possible number of hopping frequencies.

- The result shall be compared to the limit for the Frequency Occupation defined in clause 4.3.1.4.3.1 or clause 4.3.1.4.3.2. The result of this comparison shall be recorded in the test report.

Step 6:

- Make the following changes on the analyzer:

- Start Frequency: 2 400 MHz
- Stop Frequency: 2 483,5 MHz
- RBW: ~ 50 % of the Occupied Channel Bandwidth (single hopping frequency)
- VBW: \geq RBW
- Detector Mode: RMS
- Sweep time: 1 s
- Trace Mode: Max Hold
- Trigger: Free Run

NOTE 2: The above sweep time setting may result in long measuring times. To avoid such long

measuring times, an FFT analyser could be used.

- Wait for the trace to stabilize. Identify the number of hopping frequencies used by the hopping



sequence.

- The result shall be compared to the limit (value N) defined in clause 4.3.1.4.3.1 or clause 4.3.1.4.3.2. This value shall be recorded in the test report.

For equipment with blacklisted frequencies, it might not be possible to verify the number of hopping frequencies in use. However they shall comply with the requirement for Accumulated Transmit Time and Frequency Occupation assuming the minimum number of hopping frequencies (N) defined in clause 4.3.1.4.3.1 or clause 4.3.1.4.3.2 is used.

Step 7:

- For adaptive equipment, using the lowest and highest -20 dB points from the total spectrum envelope obtained in step 6, it shall be verified whether the equipment uses 70 % of the band specified in clause 1. The result shall be recorded in the test report.

WALTEK



7.2.5 Measurement Record

GFSK for Basic Bluetooth Mode

Mode	Minimum Frequency Occupation and Hopping Sequence				Result
DH5	Accumulated Dwell Time (ms)	Limit (ms)	Measure Time (ms)	Burst Number	Pass
	297.67	<=400	31600	103	
	Minimum Frequency Occupation (ms)	Limit (ms)	Measure Time (ms)	Burst Number	
	5.78	>=0	913.24	2	
	Hopping Number	Limit	Band Allocation (%)	Limit Band Allocation (%)	
79	>=15	95.4	>=70		

Mode	Minimum Frequency Occupation and Hopping Sequence				Result
2DH5	Accumulated Dwell Time (ms)	Limit (ms)	Measure Time (ms)	Burst Number	Pass
	336.4	<=400	31600	116	
	Minimum Frequency Occupation (ms)	Limit (ms)	Measure Time (ms)	Burst Number	
	5.8	>=0	916.4	3	
	Hopping Number	Limit	Band Allocation (%)	Limit Band Allocation (%)	
79	>=15	95.8	>=70		

Pi/4DQPSK for Basic Bluetooth Mode

8DPSK for Basic Bluetooth Mode

Mode	Minimum Frequency Occupation and Hopping Sequence				Result
3DH5	Accumulated Dwell Time (ms)	Limit (ms)	Measure Time (ms)	Burst Number	Pass
	90.9	<=400	31600	101	
	Minimum Frequency Occupation (ms)	Limit (ms)	Measure Time (ms)	Burst Number	
	1.78	>=0	284.4	2	
	Hopping Number	Limit	Band Allocation (%)	Limit Band Allocation (%)	
79	>=15	96	>=70		



Test Plots Mode: GFSK DH5

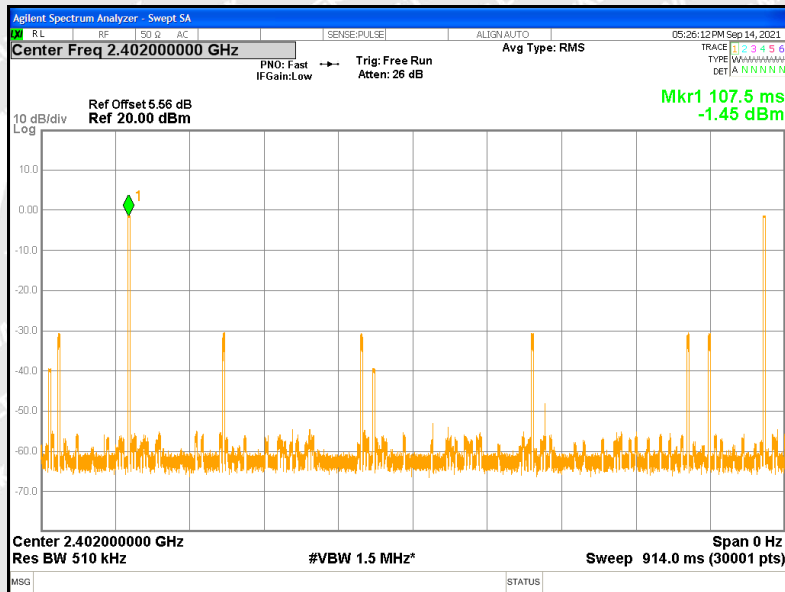
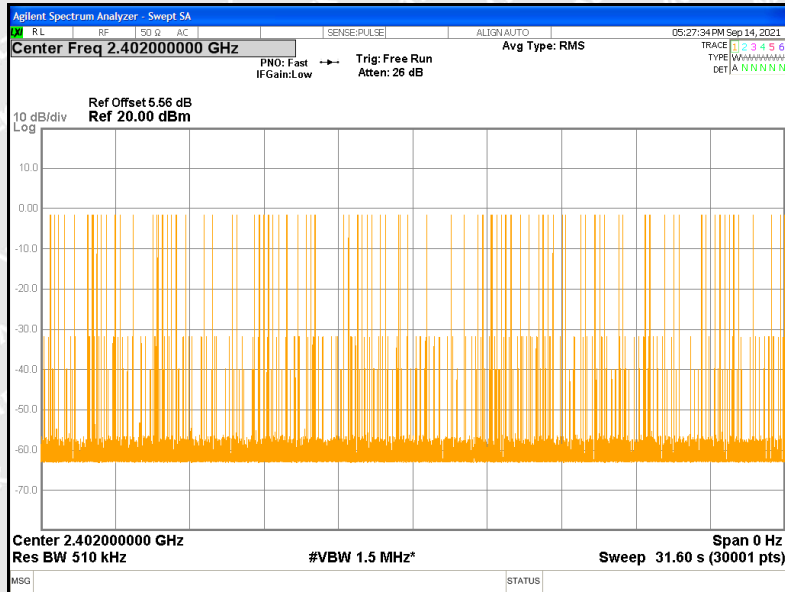

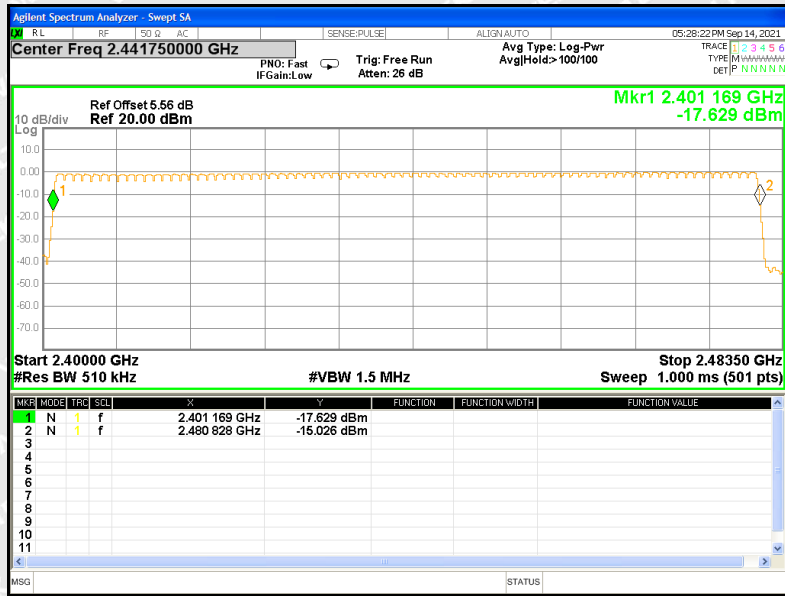

Mode: Pi/4DQPSK 2DH5

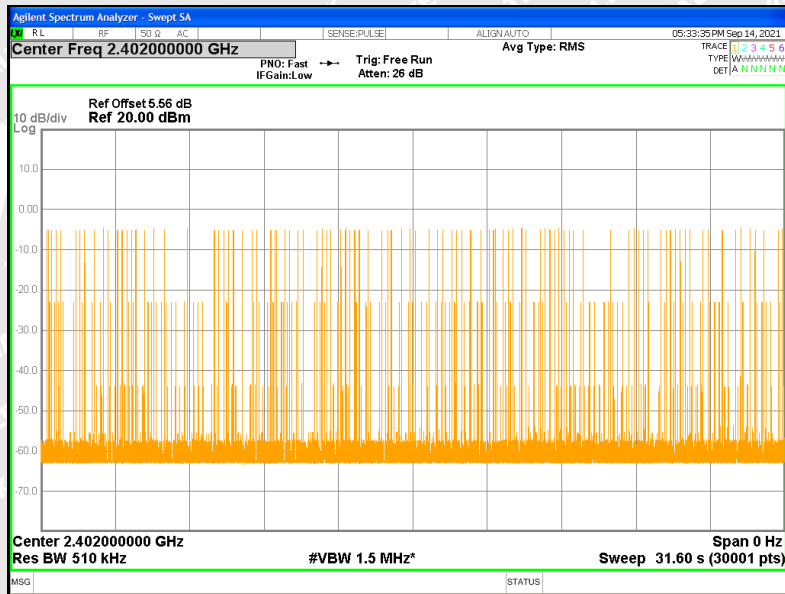

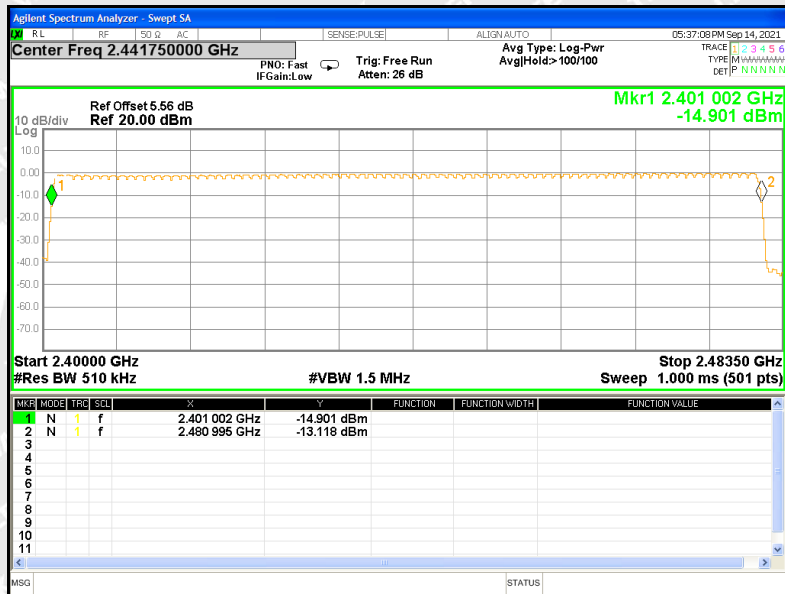
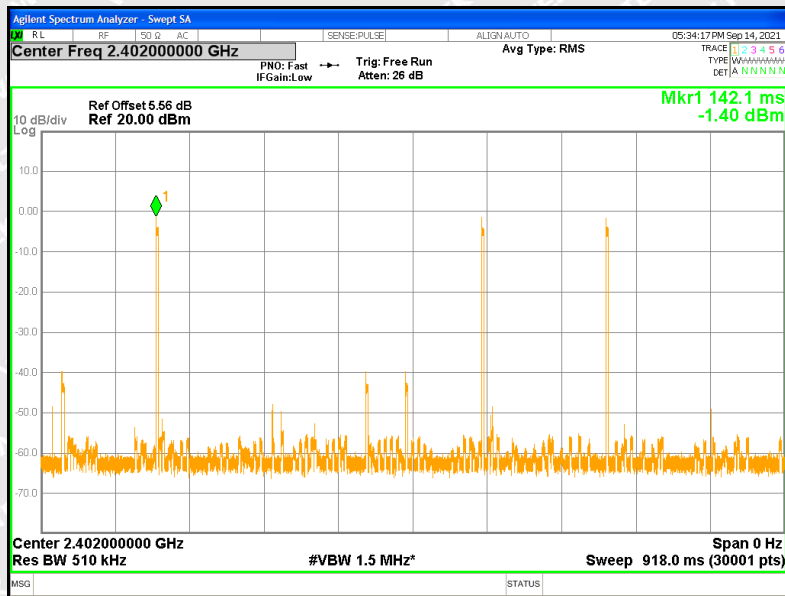



Mode: 8DPSK 3DH5

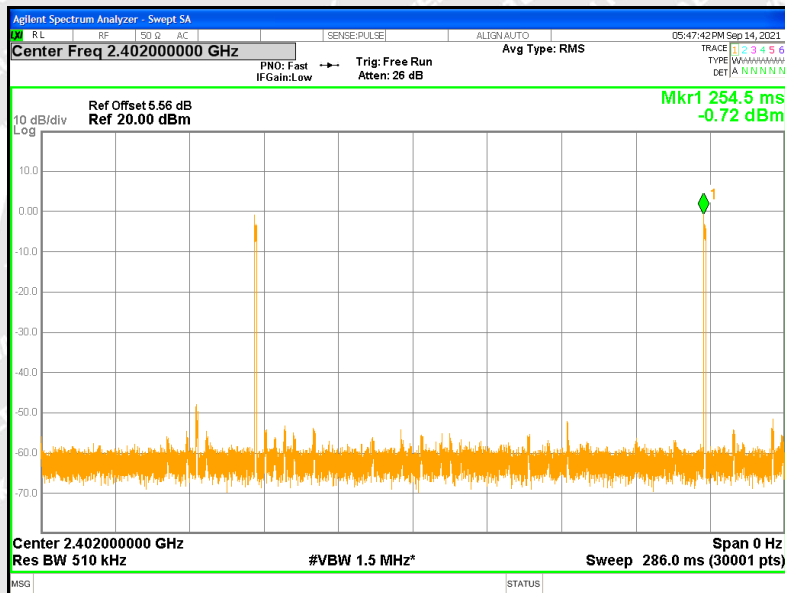
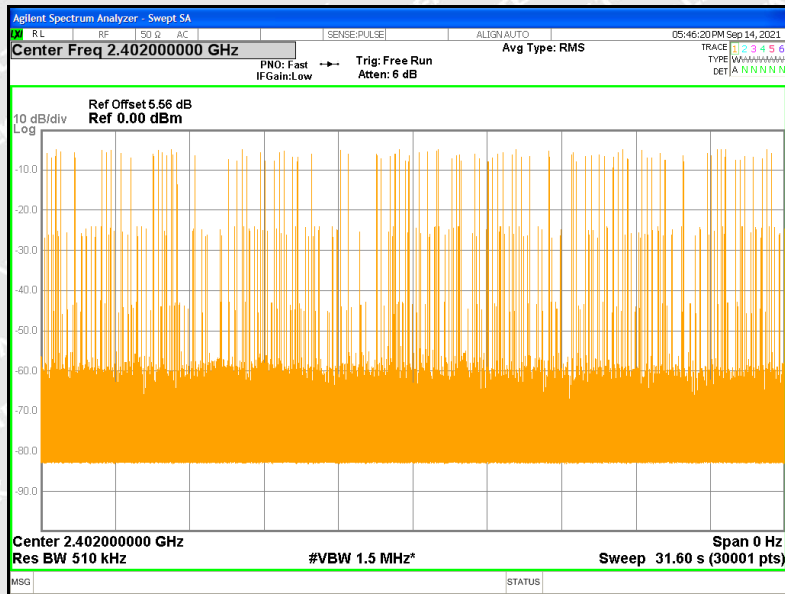

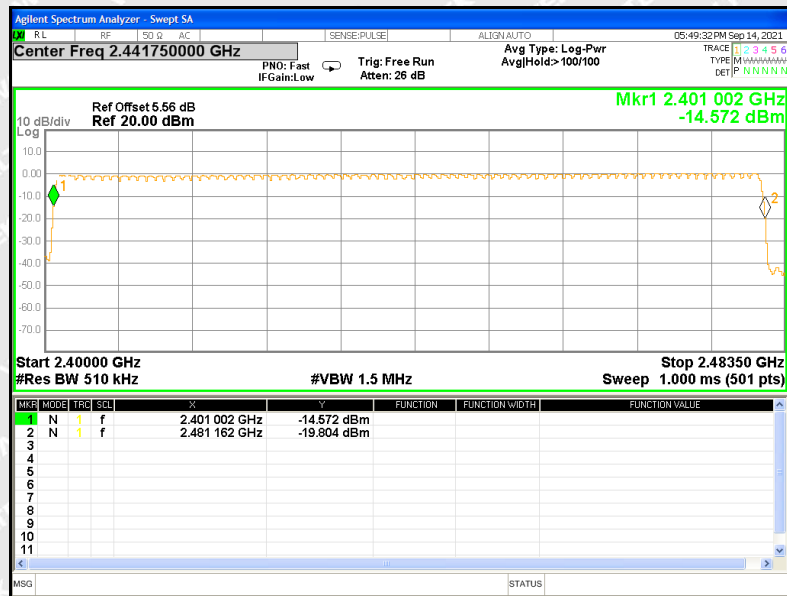

WALTEK



7.3 Hopping Frequency Separation

7.3.1 Definition:

The Hopping Frequency Separation is the frequency separation between 2 adjacent hopping frequencies.

7.3.2 Limit

Non-adaptive frequency hopping systems:

The minimum Hopping Frequency Separation shall be equal to Occupied Channel Bandwidth (see clause 4.3.1.8) of a single hop, with a minimum separation of 100kHz.

For equipment with a maximum declared RF Output power level of less than 10 dBm e.i.r.p. or for non-adaptive Frequency Hopping equipment operating in a mode where the RF Output power is less than 10 dBm e.i.r.p. only the minimum Hopping Frequency Separation of 100 kHz applies.

Adaptive frequency hopping systems:

The minimum Hopping Frequency Separation shall be 100kHz.

Adaptive Frequency Hopping equipment that switched to a non-adaptive mode for one or more hopping frequencies because interference was detected on these hopping frequencies with a level above the threshold level defined in clause 4.3.1.7.2.2, point 5 or clause 4.3.1.7.3.2, point 5, is allowed to continue to operate with a minimum Hopping Frequency Separation of 100 kHz as long as the interference remains present on these hopping frequencies. The equipment shall continue to operate in an adaptive mode on other hopping frequencies.

Adaptive Frequency Hopping equipment which decided to operate in a non-adaptive mode on one or more hopping frequencies without the presence of interference, shall comply with the limit for Hopping Frequency Separation for non-adaptive equipment defined in clause 4.3.1.5.3.1 (first paragraph) for these hopping frequencies as well as with all other requirements applicable to non-adaptive frequency hopping equipment.

7.3.3 EUT Operation Condition

The EUT was programmed to be in hopping on mode.

7.3.4 Test Procedure

The Hopping Frequency Separation as defined in clause 4.3.1.5 shall be measured and recorded using any of the following options. The selected option shall be stated in the test report.

Option 1

Step 1:

- The output of the transmitter shall be connected to a spectrum analyser or equivalent.
- The analyser shall be set as follows:
 - Centre Frequency: Centre of the two adjacent hopping frequencies
 - Frequency Span: Sufficient to see the complete power envelope of both hopping frequencies
 - RBW: 1 % of the span
 - VBW: 3 × RBW
 - Detector Mode: RMS
 - Trace Mode: Max Hold
 - Sweep time: 1 s

Step 2:

- Wait for the trace to stabilize.



- Use the marker function of the analyser to define the frequencies corresponding to the lower -20 dBr point and the upper -20 dBr point for both hopping frequencies F1 and F2. This will result in F1_L and F1_H for hopping frequency F1 and in F2_L and F2_H for hopping frequency F2. These values shall be recorded in the report.

Step 3:

- Calculate the centre frequencies F1_c and F2_c for both hopping frequencies using the formulas below. These values shall be recorded in the report.

$$F1_c = \frac{F1_L + F1_H}{2} \quad F2_c = \frac{F2_L + F2_H}{2}$$

- Calculate the -20 dBr channel bandwidth (BW_{CHAN}) using the formula below. This value shall be recorded in the report.

$$BW_{CHAN} = F1_H - F1_L$$

- Calculate the Hopping Frequency Separation (FHS) using the formula below. This value shall be recorded in the report.

$$FHS = F2_c - F1_c$$

- Compare the measured Hopping Frequency Separation with the limit defined in clause 4.3.1.5.3. In addition, for non-Adaptive Frequency Hopping equipment, the Hopping Frequency Separation shall be equal to or greater than Occupied Channel Bandwidth as defined in clause 4.3.1.8 or:

$$FHS \geq \text{Occupied Channel Bandwidth}$$

- See figure 4:

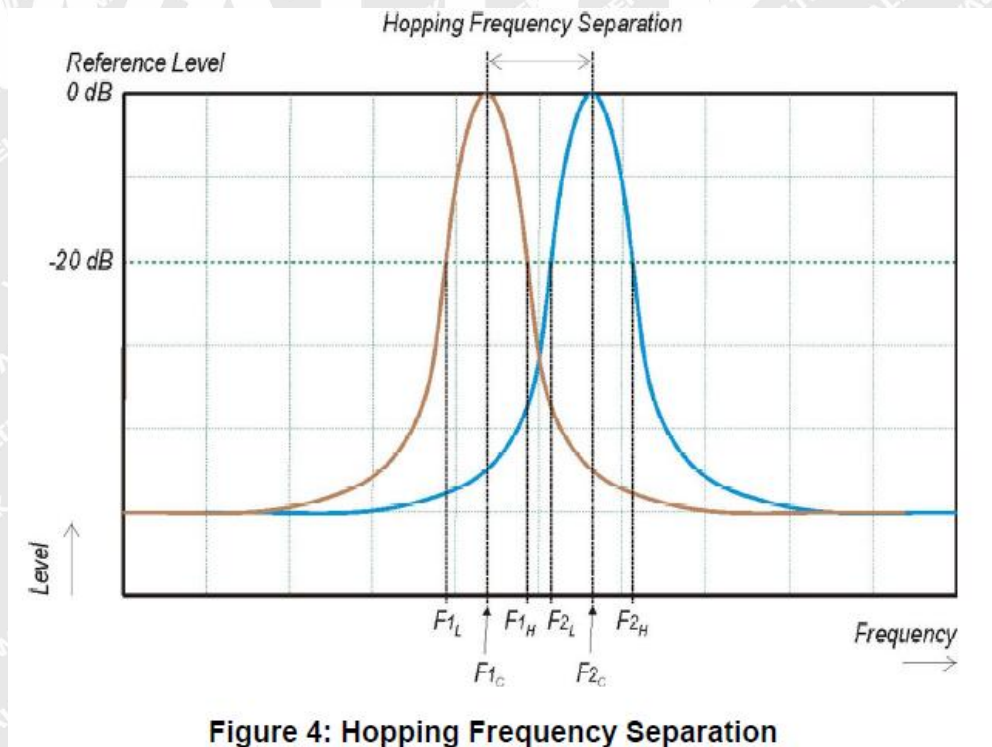

Figure 4: Hopping Frequency Separation

For adaptive equipment, in case of overlapping channels which will prevent the definition of the -20 dBr reference points F1_H and F2_L, a higher reference level (e.g. -10 dBr or -6 dBr) may be chosen to define the reference points F1_L; F1_H; F2_L and F2_H.



Alternatively, special test software may be used to:

- force the UUT to hop or transmit on a single Hopping Frequency by which the -20 dBm reference points can be measured separately for the two adjacent Hopping Frequencies; and/or
- force the UUT to operate without modulation by which the centre frequencies F1C and F2C can be measured directly.

The method used to measure the Hopping Frequency Separation shall be documented in the test report.

WALTEK

**Option 2****Step 1:**

- The output of the transmitter shall be connected to a spectrum analyser or equivalent.
- The analyser shall be set as follows:
 - Centre Frequency: Centre of the two adjacent hopping frequencies
 - Frequency Span: Sufficient to see the complete power envelope of both hopping frequencies
 - RBW: 1 % of the span
 - VBW: 3 × RBW
 - Detector Mode: RMS
 - Trace Mode: Max Hold
 - Sweep Time: 1 s

NOTE: Depending on the nature of the signal (modulation), it might be required to use a much longer sweep time, e.g. in case switching transients are present in the signals to be investigated.

Step 2:

- Wait for the trace to stabilize.
- Use the marker-delta function to determine the Hopping Frequency Separation between the centres of the two adjacent hopping frequencies (e.g. by indentifying peaks or notches at the centre of the power envelope for the two adjacent signals). This value shall be compared with the limits defined in clause 4.3.1.5.3 and shall be recorded in the test report.



7.3.5 Measurement Record

Please refer to the below photos for more details

Test Condition: Basic Bluetooth Mode				
Modulation	Mode	Separation (MHz)	Limit(kHz)	Result
GFSK	Frequencies Hopping	0.983	≥100	PASS
Pi/4DQPSK	Frequencies Hopping	1.004	≥100	PASS
8DPSK	Frequencies Hopping	0.999	≥100	PASS

Test result plot

GFSK



Pi/4DQPSK

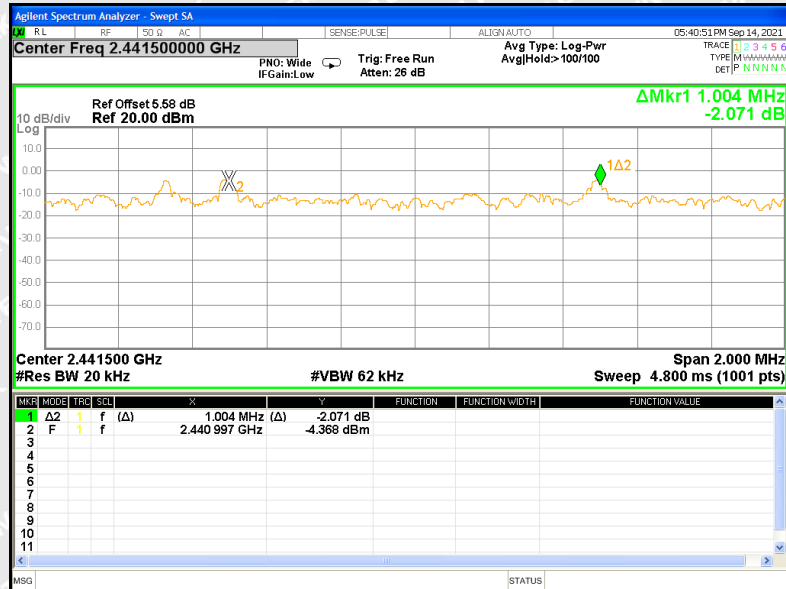



8DPSK

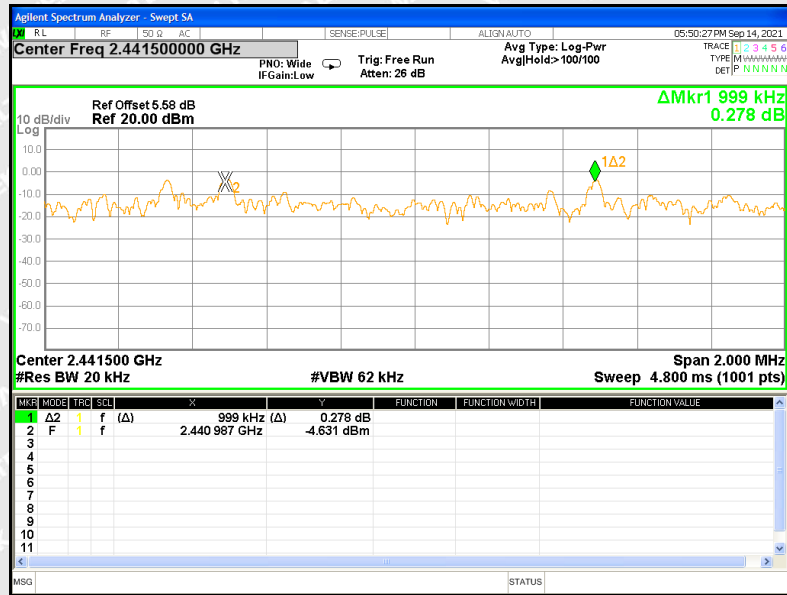

WALTEK



7.4 Adaptivity (Adaptive Frequency Hopping)

7.4.1 Adaptivity Definition

Adaptive Frequency Hopping using LBT based DAA is a mechanism by which a given hopping frequency is made 'unavailable' because an interfering signal was detected before any transmission on that frequency. This mechanism shall operate as intended in the presence of an unwanted signal on frequencies other than those of the operating band.

Non-LBT based Detect and Avoid is a mechanism for equipment using wide band modulations other than FHSS and by which a given channel is made 'unavailable' because an interfering signal was reported after the transmission in that channel. This mechanism shall operate as intended in the presence of an unwanted signal on frequencies other than those of the operating band.

In addition, this requirement does not apply for equipment with a maximum declared RF Output power level of less than 10 dBm e.i.r.p. or for equipment when operating in a mode where the RF Output power is less than 10 dBm e.i.r.p.

7.4.2 Adaptivity Limit

Refer to section 4.3.1.7.2.2 and 4.3.2.6.3.2 of ETSI EN 300 328 V2.2.2

7.4.3 EUT Operation Condition

The EUT was programmed to be in hopping on mode.

7.4.4 Test Procedure

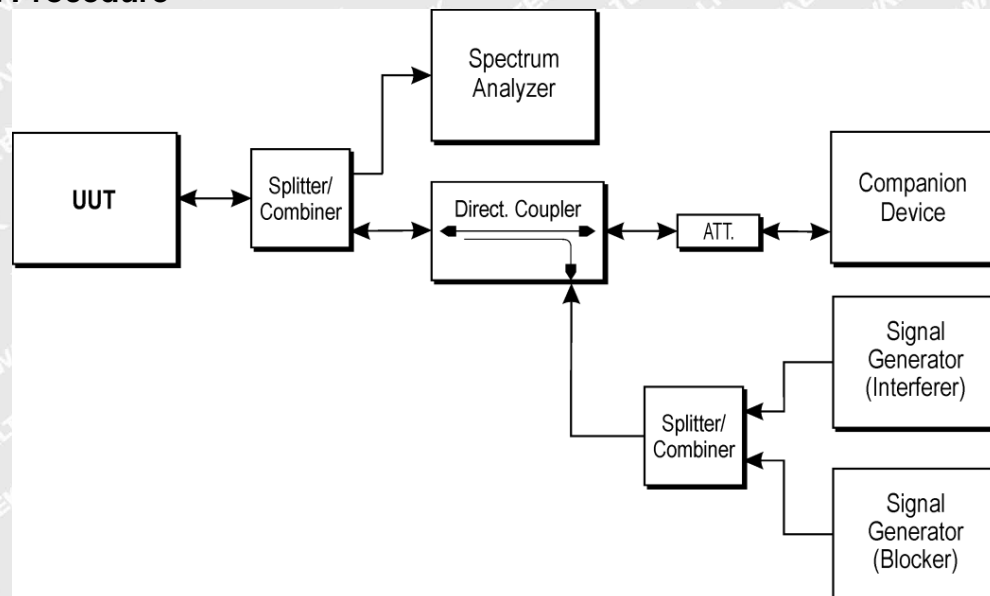

7.4.5 Measurement Record

The EIRP is less than 10dBm, so the test not applicable.



7.5 Receiver Blocking

7.5.1 Receiver Blocking Definition

Receiver blocking is a measure of the ability of the equipment to receive a wanted signal on its operating channel without exceeding a given degradation in the presence of an unwanted signal (blocking signal) on frequencies other than those of the operating band provided in table 1..

7.5.2 Receiver Blocking Limit

While maintaining the minimum performance criteria as defined in clause 4.3.1.12.4, the blocking levels at specified frequency offsets shall be equal to or greater than the limits defined for the applicable receiver category provided in table 6, table 7, table 8, table 14, table 15 or table 16

Table 6: Receiver Blocking parameters for Receiver Category 1 equipment

Wanted signal mean power from companion device (dBm) (see notes 1 and 4)	Blocking signal frequency (MHz)	Blocking signal power (dBm) (see note 4)	Type of blocking signal
(-133 dBm + 10 × log ₁₀ (OCBW)) or -68 dBm whichever is less (see note 2)	2 380	-34	CW
	2 504		
(-139 dBm + 10 × log ₁₀ (OCBW)) or -74 dBm whichever is less (see note 3)	2 300		
	2 330		
	2 360		
	2 524		
	2 584		
	2 674		

NOTE 1: OCBW is in Hz.

NOTE 2: In case of radiated measurements using a companion device and the level of the wanted signal from the companion device cannot be determined, a relative test may be performed using a wanted signal up to $P_{min} + 26$ dB where P_{min} is the minimum level of wanted signal required to meet the minimum performance criteria as defined in clause 4.3.1.12.3 in the absence of any blocking signal.

NOTE 3: In case of radiated measurements using a companion device and the level of the wanted signal from the companion device cannot be determined, a relative test may be performed using a wanted signal up to $P_{min} + 20$ dB where P_{min} is the minimum level of wanted signal required to meet the minimum performance criteria as defined in clause 4.3.1.12.3 in the absence of any blocking signal.

NOTE 4: The level specified is the level at the UUT receiver input assuming a 0 dBi antenna assembly gain. In case of conducted measurements, this level has to be corrected for the (in-band) antenna assembly gain (G). In case of radiated measurements, this level is equivalent to a power flux density (PFD) in front of the UUT antenna with the UUT being configured/positioned as recorded in clause 5.4.3.2.2.

**Table 7: Receiver Blocking parameters receiver Category 2 equipment**

Wanted signal mean power from companion device (dBm) (see notes 1 and 3)	Blocking signal frequency (MHz)	Blocking signal power (dBm) (see note 3)	Type of blocking signal
$(-139 \text{ dBm} + 10 \times \log_{10}(\text{OCBW}) + 10 \text{ dB})$ or $(-74 \text{ dBm} + 10 \text{ dB})$ whichever is less (see note 2)	2 380 2 504 2 300 2 584	-34	CW
NOTE 1: OCBW is in Hz.			
NOTE 2: In case of radiated measurements using a companion device and the level of the wanted signal from the companion device cannot be determined, a relative test may be performed using a wanted signal up to $P_{\min} + 26 \text{ dB}$ where P_{\min} is the minimum level of wanted signal required to meet the minimum performance criteria as defined in clause 4.3.1.12.3 in the absence of any blocking signal.			
NOTE 3: The level specified is the level at the UUT receiver input assuming a 0 dBi antenna assembly gain. In case of conducted measurements, this level has to be corrected for the (in-band) antenna assembly gain (G). In case of radiated measurements, this level is equivalent to a power flux density (PFD) in front of the UUT antenna with the UUT being configured/positioned as recorded in clause 5.4.3.2.2.			

Table 8: Receiver Blocking parameters receiver Category 3 equipment

Wanted signal mean power from companion device (dBm) (see notes 1 and 3)	Blocking signal frequency (MHz)	Blocking signal power (dBm) (see note 3)	Type of blocking signal
$(-139 \text{ dBm} + 10 \times \log_{10}(\text{OCBW}) + 20 \text{ dB})$ or $(-74 \text{ dBm} + 20 \text{ dB})$ whichever is less (see note 2)	2 380 2 504 2 300 2 584	-34	CW
NOTE 1: OCBW is in Hz.			
NOTE 2: In case of radiated measurements using a companion device and the level of the wanted signal from the companion device cannot be determined, a relative the test may be performed using a wanted signal up to $P_{\min} + 30 \text{ dB}$ where P_{\min} is the minimum level of wanted signal required to meet the minimum performance criteria as defined in clause 4.3.1.12.3 in the absence of any blocking signal.			
NOTE 3: The level specified is the level at the UUT receiver input assuming a 0 dBi antenna assembly gain. In case of conducted measurements, this level has to be corrected for the (in-band) antenna assembly gain (G). In case of radiated measurements, this level is equivalent to a power flux density (PFD) in front of the UUT antenna with the UUT being configured/positioned as recorded in clause 5.4.3.2.2.			

**Table 14: Receiver Blocking parameters for Receiver Category 1 equipment**

Wanted signal mean power from companion device (dBm) (see notes 1 and 4)	Blocking signal frequency (MHz)	Blocking signal power (dBm) (see note 4)	Type of blocking signal
$(-133 \text{ dBm} + 10 \times \log_{10}(\text{OCBW}))$ or -68 dBm whichever is less (see note 2)	2 380 2 504	-34	CW
$(-139 \text{ dBm} + 10 \times \log_{10}(\text{OCBW}))$ or -74 dBm whichever is less (see note 3)	2 300 2 330 2 360 2 524 2 584 2 674		

NOTE 1: OCBW is in Hz.

NOTE 2: In case of radiated measurements using a companion device and the level of the wanted signal from the companion device cannot be determined, a relative test may be performed using a wanted signal up to $P_{\min} + 26 \text{ dB}$ where P_{\min} is the minimum level of wanted signal required to meet the minimum performance criteria as defined in clause 4.3.1.12.3 in the absence of any blocking signal.

NOTE 3: In case of radiated measurements using a companion device and the level of the wanted signal from the companion device cannot be determined, a relative test may be performed using a wanted signal up to $P_{\min} + 20 \text{ dB}$ where P_{\min} is the minimum level of wanted signal required to meet the minimum performance criteria as defined in clause 4.3.1.12.3 in the absence of any blocking signal.

NOTE 4: The level specified is the level at the UUT receiver input assuming a 0 dBi antenna assembly gain. In case of conducted measurements, this level has to be corrected for the (in-band) antenna assembly gain (G). In case of radiated measurements, this level is equivalent to a power flux density (PFD) in front of the UUT antenna with the UUT being configured/positioned as recorded in clause 5.4.3.2.2.

Table 15: Receiver Blocking parameters receiver Category 2 equipment

Wanted signal mean power from companion device (dBm) (see notes 1 and 3)	Blocking signal frequency (MHz)	Blocking signal power (dBm) (see note 3)	Type of blocking signal
$(-139 \text{ dBm} + 10 \times \log_{10}(\text{OCBW}) + 10 \text{ dB})$ or $(-74 \text{ dBm} + 10 \text{ dB})$ whichever is less (see note 2)	2 380 2 504 2 300 2 584	-34	CW

NOTE 1: OCBW is in Hz.

NOTE 2: In case of radiated measurements using a companion device and the level of the wanted signal from the companion device cannot be determined, a relative test may be performed using a wanted signal up to $P_{\min} + 26 \text{ dB}$ where P_{\min} is the minimum level of wanted signal required to meet the minimum performance criteria as defined in clause 4.3.1.12.3 in the absence of any blocking signal.

NOTE 3: The level specified is the level at the UUT receiver input assuming a 0 dBi antenna assembly gain. In case of conducted measurements, this level has to be corrected for the (in-band) antenna assembly gain (G). In case of radiated measurements, this level is equivalent to a power flux density (PFD) in front of the UUT antenna with the UUT being configured/positioned as recorded in clause 5.4.3.2.2.

**Table 16: Receiver Blocking parameters receiver Category 3 equipment**

Wanted signal mean power from companion device (dBm) (see notes 1 and 3)	Blocking signal frequency (MHz)	Blocking signal power (dBm) (see note 3)	Type of blocking signal
(-139 dBm + 10 × log ₁₀ (OCBW) + 20 dB) or (-74 dBm + 20 dB) whichever is less (see note 2)	2 380 2 504 2 300 2 584	-34	CW

NOTE 1: OCBW is in Hz.
NOTE 2: In case of radiated measurements using a companion device and the level of the wanted signal from the companion device cannot be determined, a relative test may be performed using a wanted signal up to $P_{min} + 30$ dB where P_{min} is the minimum level of wanted signal required to meet the minimum performance criteria as defined in clause 4.3.1.12.3 in the absence of any blocking signal.
NOTE 3: The level specified is the level at the UUT receiver input assuming a 0 dBi antenna assembly gain. In case of conducted measurements, this level has to be corrected for the (in-band) antenna assembly gain (G). In case of radiated measurements, this level is equivalent to a power flux density (PFD) in front of the UUT antenna with the UUT being configured/positioned as recorded in clause 5.4.3.2.2.

The conformance tests for this requirement are defined in clause 5.4.11.

7.5.3 EUT Operation Condition

The EUT was programmed to be in hopping on mode.

7.5.4 Test Procedure

For systems using multiple receive chains only one chain (antenna port) need to be tested. All other receiver inputs shall be terminated.

Figure 6 shows the test set-up which can be used for performing the receiver blocking test.

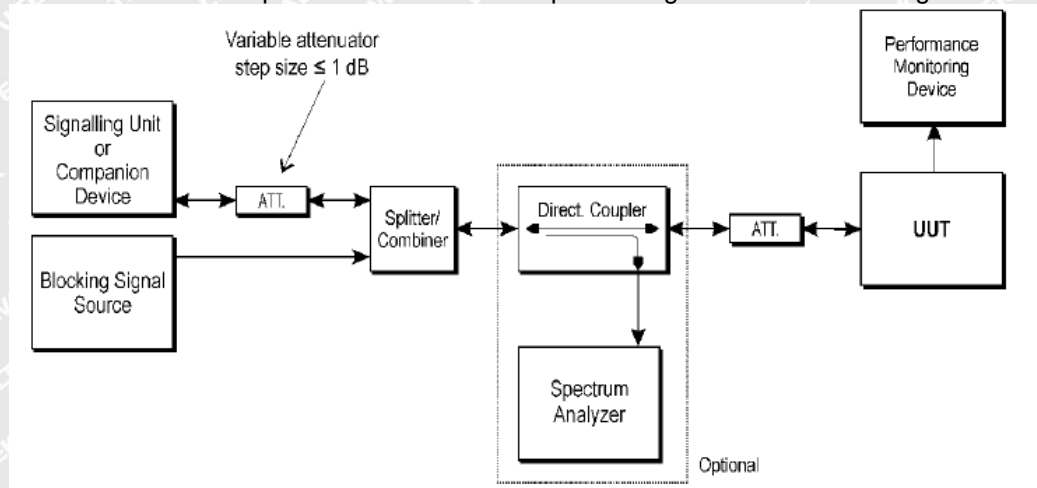
**Figure 6: Test Set-up for receiver blocking**

The procedure in step 1 to step 6 below shall be used to verify the receiver blocking requirement as described in clause 4.3.1.12 or clause 4.3.2.11.

Table 6, table 7 and table 8 in clause 4.3.1.12.4 contain the applicable blocking frequencies and blocking levels for each of the receiver categories for testing Receiver Blocking on frequency hopping equipment.

Table 14, table 15 and table 16 in clause 4.3.2.11.4 contain the applicable blocking frequencies and blocking levels for each of the receiver categories for testing Receiver Blocking on equipment using wide band modulations other than FHSS.

**Step 1:**

- For non-frequency hopping equipment, the UUT shall be set to the lowest operating channel.

Step 2:

- The blocking signal generator is set to the first frequency as defined in the appropriate table corresponding to the receiver category and type of equipment.

Step 3:

- With the blocking signal generator switched off, a communication link is established between the UUT and the associated companion device using the test setup shown in figure 6. The attenuation of the variable attenuator shall be increased in 1 dB steps to a value at which the minimum performance criteria as specified in clause 4.3.1.12.3 or clause 4.3.2.11.3 is still met. The resulting level for the wanted signal at the input of the UUT is Pmin.

- This signal level (Pmin) is increased by the value provided in the table corresponding to the receiver category and type of equipment.

Step 4:

- The blocking signal at the UUT is set to the level provided in the table corresponding to the receiver category and type of equipment. It shall be verified and recorded in the test report that the performance criteria as specified in clause 4.3.1.12.3 or clause 4.3.2.11.3 is met.

Step 5:

- Repeat step 4 for each remaining combination of frequency and level for the blocking signal as provided in the table corresponding to the receiver category and type of equipment.

Step 6:

- For non-frequency hopping equipment, repeat step 2 to step 5 with the UUT operating at the highest operating channel.

7.5.5 Measurement Record

Receiver Blocking parameters receiver category 2 equipment

Test Condition: Basic Bluetooth Mode							
Modulation	Mode	Blocking Frequency(MHz)	Blocking Power(dB)	Measure d PER(%)	Pmin (dbm)	Limit (%)	Result
GFSK	Loopback	2380	-34	6.1	-74	10	PASS
		2504	-34	5.6		10	PASS
		2300	-34	4.8		10	PASS
		2584	-34	4.9		10	PASS
Pi/4DQPSK	Loopback	2380	-34	6.4	-81	10	PASS
		2504	-34	5.5		10	PASS
		2300	-34	4.2		10	PASS
		2584	-34	4.7		10	PASS
8DPSK	Loopback	2380	-34	5.1	-79	10	PASS
		2504	-34	5.4		10	PASS
		2300	-34	6.3		10	PASS
		2584	-34	7.0		10	PASS

NOTE: Pmin value is measured value



7.6 Occupied Channel Bandwidth

7.6.1 Definition

The Occupied Channel Bandwidth is the bandwidth that contains 99 % of the power of the signal when considering a single hopping frequency.

7.6.2 Limit

The Occupied Channel Bandwidth for each hopping frequency shall fall completely within the band given in table 1.

For non-adaptive Frequency Hopping equipment with e.i.r.p greater than 10 dBm, the Occupied Channel Bandwidth for every occupied hopping frequency shall be equal to or less than the Nominal Channel Bandwidth declared by the supplier. See clause 5.4.1 j). This declared value shall not be greater than 5 MHz.

7.6.3 EUT Operation Condition

The EUT was programmed to be in continuously transmitting mode.

7.6.4 Test Procedure

Step 1:

Connect the UUT to the spectrum analyser and use the following settings:

- Centre Frequency: The centre frequency of the channel under test
- Resolution BW: ~ 1 % of the span without going below 1 %
- Video BW: $3 \times \text{RBW}$
- Frequency Span: $2 \times \text{Nominal Channel Bandwidth}$
- Detector Mode: RMS
- Trace Mode: Max Hold
- Sweep time: 1 s

Step 2:

Wait for the trace to stabilize.

Find the peak value of the trace and place the analyser marker on this peak.

Step 3:

Use the 99 % bandwidth function of the spectrum analyser to measure the Occupied Channel Bandwidth of the UUT.

This value shall be recorded.

NOTE: Make sure that the power envelope is sufficiently above the noise floor of the analyser to avoid the noise signals left and right from the power envelope being taken into account by this measurement.



7.6.5 Measurement Record

Condition: Basic Bluetooth Mode

Modulation	Frequency	Frequency Range		Occupied Channel
	(MHz)	(MHz)		
GFSK	Low	2401.553	/	0.865
	High	/	2480.419	0.867
Pi/4DQPSK	Low	2401.396	/	1.188
	High	/	2480.584	1.187
8DPSK	Low	2401.402	/	1.169
	High	/	2480.572	1.171

WALTEK



Test Plot

GFSK:

Low Channel

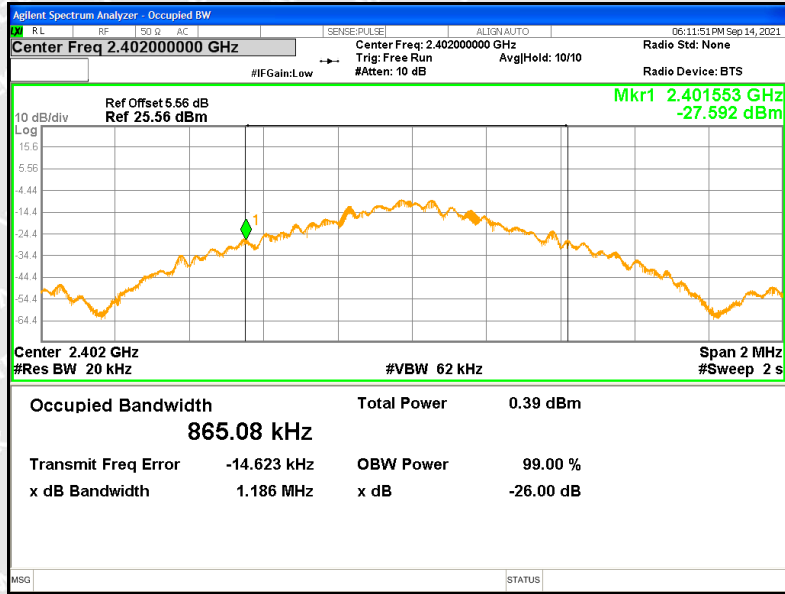

High Channel

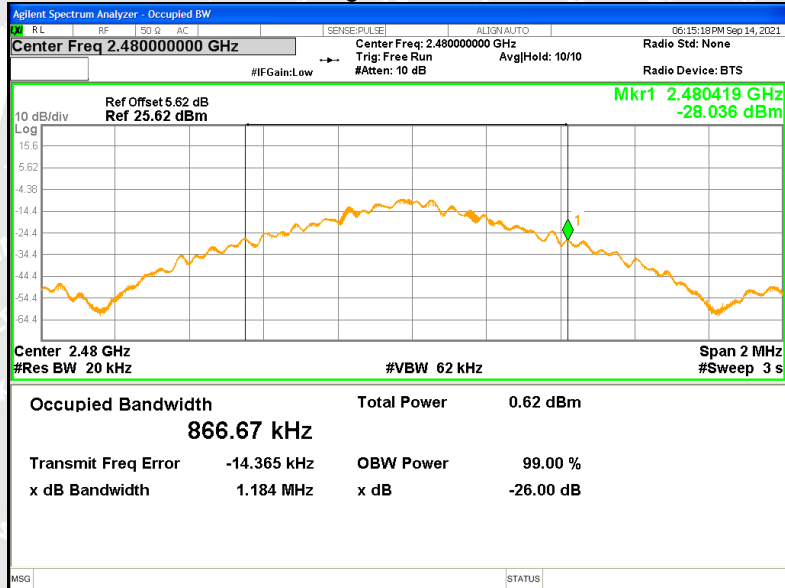



Pi/4DQPSK:
Low Channel

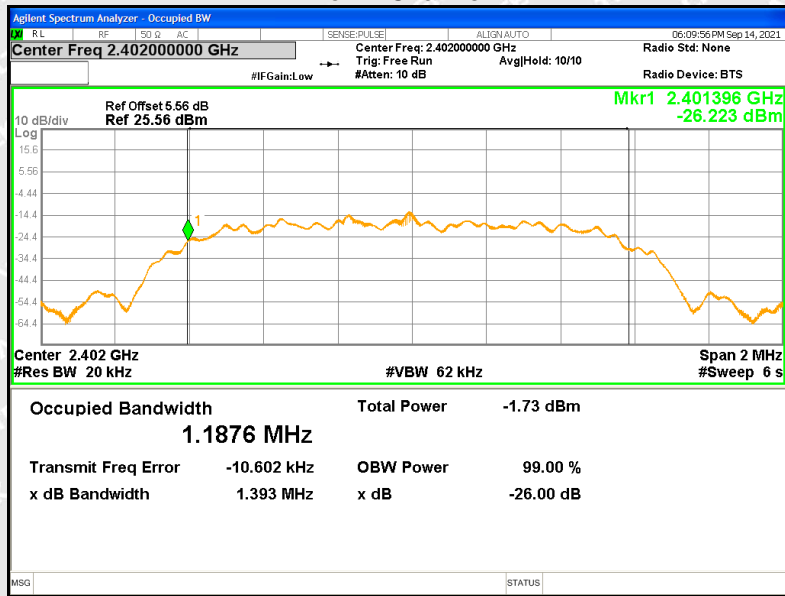

High Channel

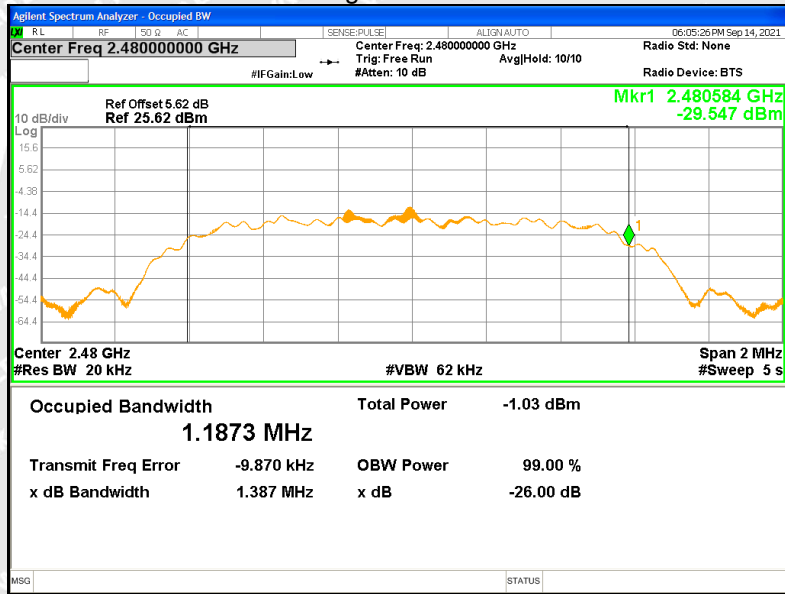



8DPSK :

Low Channel

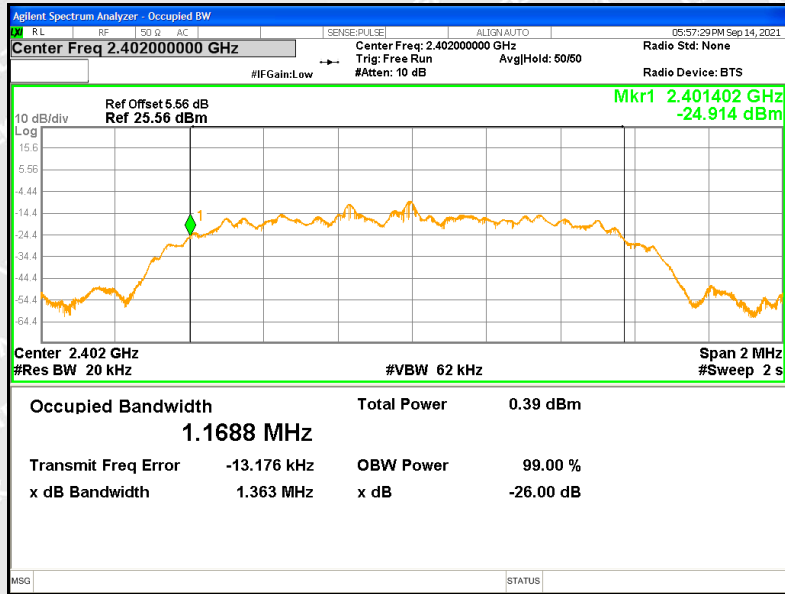

High Channel

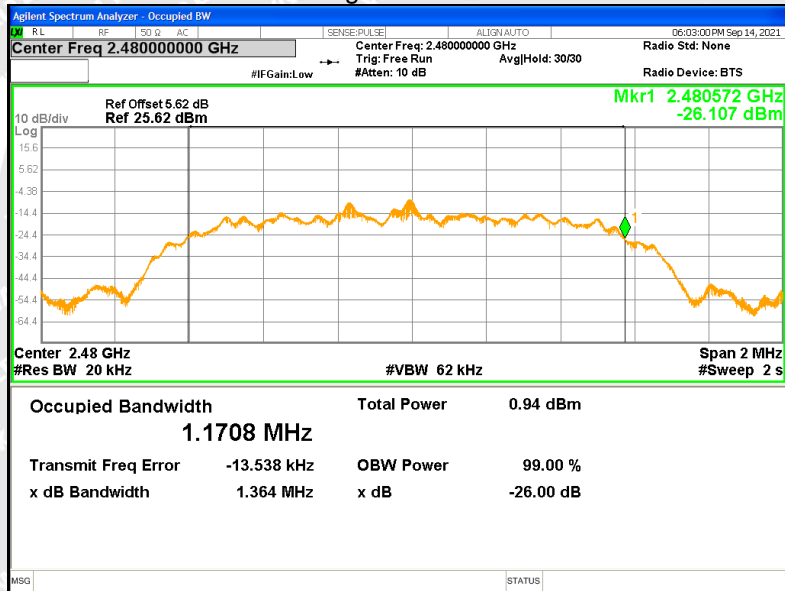



7.7 Transmitter unwanted emissions in the out-of-band domain

7.7.1 Definition

Transmitter unwanted emissions in the out-of-band domain are emissions when the equipment is in Transmit mode, on frequencies immediately outside the necessary bandwidth which results from the modulation process, but excluding spurious emissions.

7.7.2 Limit

The transmitter unwanted emissions in the out-of-band domain but outside the allocated band, shall not exceed the values provided by the mask in figure 3.

Within the band specified in table 1, the Out-of-band emissions are fulfilled by compliance with the Occupied Channel Bandwidth requirement in clause 4.3.2.7.

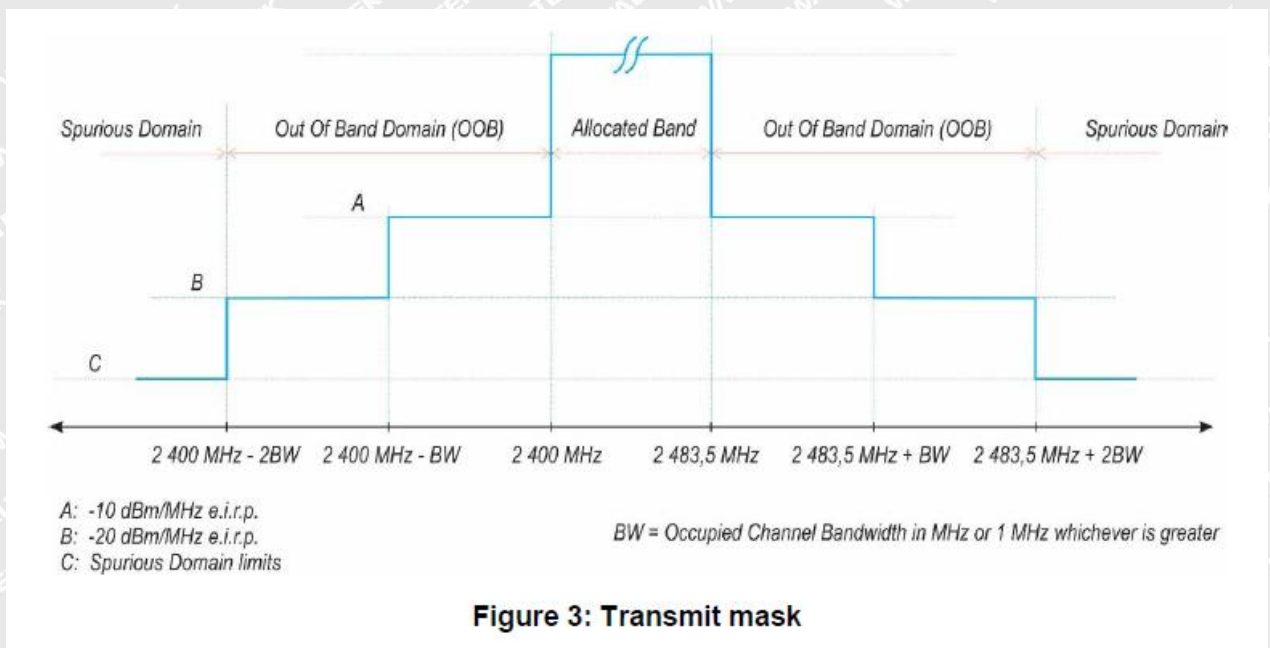

7.7.3 EUT Operation Condition

The EUT was programmed to be in continuously transmitting mode.

7.7.4 Test Procedure

The applicable mask is defined by the measurement results from the tests performed under clause 5.4.7 (Occupied Channel Bandwidth).

The Out-of-band emissions within the different horizontal segments of the mask provided in figures 1 and 3 shall be measured using the procedure in step 1 to step 6 below. This method assumes the spectrum analyser is equipped with the Time Domain Power option.

Step 1:

- Connect the UUT to the spectrum analyser and use the following settings:
 - Centre Frequency: 2 484 MHz
 - Span: 0 Hz
 - Resolution BW: 1 MHz
 - Filter mode: Channel filter



- Video BW: 3 MHz
- Detector Mode: RMS
- Trace Mode: Max Hold
- Sweep Mode: Continuous
- Sweep Points: Sweep Time [s] / (1 μ s) or 5 000 whichever is greater
- Trigger Mode: Video trigger

NOTE 1: In case video triggering is not possible, an external trigger source may be used.

- Sweep Time: > 120 % of the duration of the longest burst detected during the measurement of the RF Output Power

Step 2 (segment 2 483,5 MHz to 2 483,5 MHz + BW):

- Adjust the trigger level to select the transmissions with the highest power level.
- For frequency hopping equipment operating in a normal hopping mode, the different hops will result in signal bursts with different power levels. In this case the burst with the highest power level shall be selected.
- Set a window (start and stop lines) to match with the start and end of the burst and in which the RMS power shall be measured using the Time Domain Power function.
- Select RMS power to be measured within the selected window and note the result which is the RMS power within this 1 MHz segment (2 483,5 MHz to 2 484,5 MHz). Compare this value with the applicable limit provided by the mask.
- Increase the centre frequency in steps of 1 MHz and repeat this measurement for every 1 MHz segment within the range 2 483,5 MHz to 2 483,5 MHz + BW. The centre frequency of the last 1 MHz segment shall be set to 2 483,5 MHz + BW - 0,5 MHz (which means this may partly overlap with the previous 1 MHz segment).

Step 3 (segment 2 483,5 MHz + BW to 2 483,5 MHz + 2BW):

- Change the centre frequency of the analyser to 2 484 MHz + BW and perform the measurement for the first 1 MHz segment within range 2 483,5 MHz + BW to 2 483,5 MHz + 2BW. Increase the centre frequency in 1 MHz steps and repeat the measurements to cover this whole range. The centre frequency of the last 1 MHz segment shall be set to 2 483,5 MHz + 2 BW - 0,5 MHz (which means this may partly overlap with the previous 1 MHz segment).

Step 4 (segment 2 400 MHz - BW to 2 400 MHz):

- Change the centre frequency of the analyser to 2 399,5 MHz and perform the measurement for the first 1 MHz segment within range 2 400 MHz - BW to 2 400 MHz. Reduce the centre frequency in 1 MHz steps and repeat the measurements to cover this whole range. The centre frequency of the last 1 MHz segment shall be set to 2 400 MHz - BW + 0,5 MHz (which means this may partly overlap with the previous 1 MHz segment).

Step 5 (segment 2 400 MHz - 2BW to 2 400 MHz - BW):

- Change the centre frequency of the analyser to 2 399,5 MHz - BW and perform the measurement for the first 1 MHz segment within range 2 400 MHz - 2BW to 2 400 MHz - BW. Reduce the centre frequency in 1 MHz steps and repeat the measurements to cover this whole range. The centre frequency of the last 1 MHz segment shall be set to 2 400 MHz - 2BW + 0,5 MHz (which means this may partly overlap with the previous 1 MHz segment).

Step 6:

- In case of conducted measurements on equipment with a single transmit chain, the declared antenna assembly gain "G" in dBi shall be added to the results for each of the 1 MHz segments and compared with the limits

provided by the mask given in figure 1 or figure 3. If more than one antenna assembly is intended for this power setting, the antenna with the highest gain shall be considered.



• In case of conducted measurements on smart antenna systems (equipment with multiple transmit chains), the measurements need to be repeated for each of the active transmit chains. The declared antenna assembly gain "G" in dBi for a single antenna shall be added to these results. If more than one antenna assembly is intended for this power setting, the antenna with the highest gain shall be considered. Comparison with the applicable limits shall be done using any of the options given below:

- Option 1: the results for each of the transmit chains for the corresponding 1 MHz segments shall be added. The additional beamforming gain "Y" in dB shall be added as well and the resulting values compared with the limits provided by the mask given in figure 1 or figure 3.

- Option 2: the limits provided by the mask given in figure 1 or figure 3 shall be reduced by $10 \times \log_{10}(A_{ch})$ and the additional beamforming gain "Y" in dB. The results for each of the transmit chains shall be individually compared with these reduced limits.

NOTE 2: A_{ch} refers to the number of active transmit chains.

It shall be recorded whether the equipment complies with the mask provided in figure 1 or figure 3.

WALTEK



7.7.5 Measurement Record

Condition: Basic Bluetooth Mode

Mode		GFSK Low channel		Mode		GFSK High channel	
Frequency	Level	Limit	Frequency	Level	Limit	Frequency	Limit
(MHz)	(dBm)	(dBm)	(MHz)	(dBm)	(dBm)	(MHz)	(dBm)
2399.5	-60.05	-10	2484	-60.75	-10		
2398.5	-59.73	-20	2485	-60.89	-20		

Mode		Pi/4DQPSK Low channel		Mode		Pi/4DQPSK High channel	
Frequency	Level	Limit	Frequency	Level	Limit	Frequency	Limit
(MHz)	(dBm)	(dBm)	(MHz)	(dBm)	(dBm)	(MHz)	(dBm)
2399.5	-61.11	-10	2484	-59.85	-10		
2398.5	-61.05	-20	2485	-59.84	-20		

Mode		8DPSK Low channel		Mode		8DPSK High channel	
Frequency	Level	Limit	Frequency	Level	Limit	Frequency	Limit
(MHz)	(dBm)	(dBm)	(MHz)	(dBm)	(dBm)	(MHz)	(dBm)
2399.5	-60.91	-10	2484	-60.05	-25		
2398.5	-60.61	-20	2485	-59.27	-20		

Condition: Basic Bluetooth Mode

Modulation	Test conditions		OOB	
			Low Channel	High Channel
GFSK	Normal		PASS	PASS
	Extreme	LTLV	PASS	PASS
		LTHV	PASS	PASS
		HTLV	PASS	PASS
		HTHV	PASS	PASS
Pi/4DQPSK	Normal		PASS	PASS
	Extreme	LTLV	PASS	PASS
		LTHV	PASS	PASS
		HTLV	PASS	PASS
		HTHV	PASS	PASS
8DPSK	Normal		PASS	PASS
	Extreme	LTLV	PASS	PASS
		LTHV	PASS	PASS
		HTLV	PASS	PASS
		HTHV	PASS	PASS



Test Plots(Basic Bluetooth Mode)

GFSK

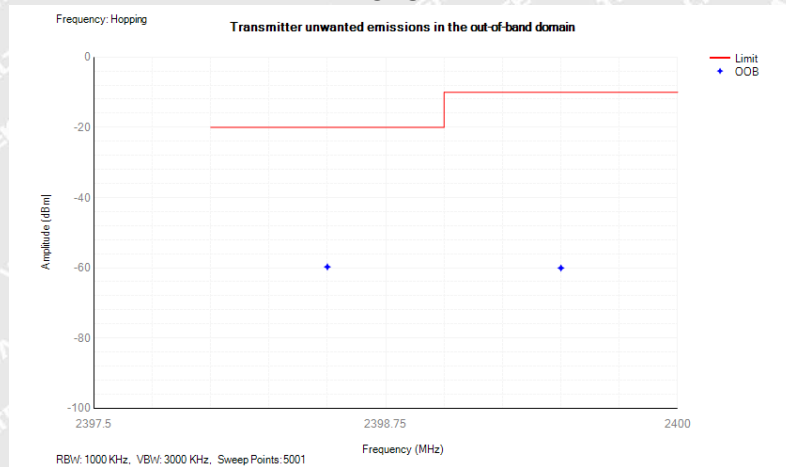

Pi/4DQPSK

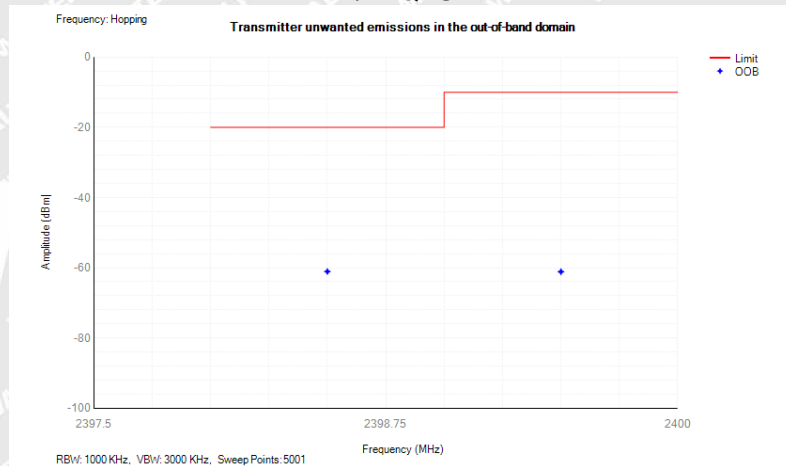

8DPSK

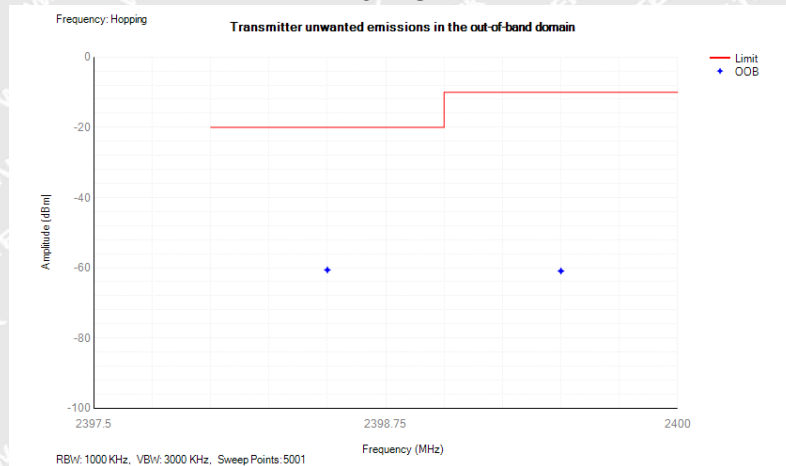



7.8 Transmitter unwanted emissions in the spurious domain

7.8.1 Definition

Transmitter unwanted emissions in the spurious domain are emissions outside the allocated band and outside the out-of-band domain as indicated in figure 3 when the equipment is in Transmit mode.

7.8.2 Limit

The transmitter unwanted emissions in the spurious domain shall not exceed the values given in table 12.

In case of equipment with antenna connectors, these limits apply to emissions at the antenna port (conducted). For emissions radiated by the cabinet or emissions radiated by integral antenna equipment (without antenna connectors), these limits are e.i.r.p. for emissions up to 1 GHz and as e.i.r.p. for emissions above 1 GHz.

Table 12: Transmitter limits for spurious emissions

Frequency range	Maximum power, e.i.r.p. (≤ 1 GHz) e.i.r.p. (> 1 GHz)	Bandwidth
30 MHz to 47 MHz	-36 dBm	100 kHz
47 MHz to 74 MHz	-54 dBm	100 kHz
74 MHz to 87.5 MHz	-36 dBm	100 kHz
87.5 MHz to 118 MHz	-54 dBm	100 kHz
118 MHz to 174 MHz	-36 dBm	100 kHz
174 MHz to 230 MHz	-54 dBm	100 kHz
230 MHz to 470 MHz	-36 dBm	100 kHz
470 MHz to 694 MHz	-54 dBm	100 kHz
694 MHz to 1 GHz	-36 dBm	100 kHz
1 GHz to 12.75 GHz	-30 dBm	1 MHz

7.8.3 EUT Operation Condition

The EUT was programmed to be in continuously transmitting mode.

7.8.4 Test Procedure

The test site as described in annex B and applicable measurement procedures as described in annex C shall be used.

The test procedure is further as described under clause 5.4.9.2.1.



7.8.5 Measurement Record

Test Condition: Normal Mode (GFSK of basic Bluetooth Low channel)										
Frequency	Receiver Reading	Turn table Angle	RX Antenna		Substituted			Absolute Level	Limit	Margin
			Height	Polar	SG Level	Cable	Antenna Gain			
(MHz)	(dBμV)	Degree	(m)	(H/V)	(dBm)	(dB)	(dB)	(dBm)	(dBm)	(dB)
450.57	45.20	124	1.3	H	-55.30	0.18	0.00	-55.48	-36	-19.48
450.57	43.17	3	1.8	V	-56.18	0.18	0.00	-56.36	-36	-20.36
4804.00	56.29	320	1.7	H	-53.17	2.30	11.50	-43.97	-30	-13.97
4804.00	55.12	64	1.6	V	-53.07	2.30	11.50	-43.87	-30	-13.87
7206.00	57.35	156	1.8	H	-49.18	2.90	12.00	-40.08	-30	-10.08
7206.00	52.19	65	1.1	V	-54.63	2.90	12.00	-45.53	-30	-15.53
Test Condition: Normal Mode (GFSK of basic Bluetooth High channel)										
Frequency	Receiver Reading	Turn table Angle	RX Antenna		Substituted			Absolute Level	Limit	Margin
			Height	Polar	SG Level	Cable	Antenna Gain			
(MHz)	(dBμV)	Degree	(m)	(H/V)	(dBm)	(dB)	(dB)	(dBm)	(dBm)	(dB)
450.57	45.62	331	1.6	H	-54.88	0.18	0.00	-55.06	-36	-19.06
450.57	43.28	77	1.6	V	-56.07	0.18	0.00	-56.25	-36	-20.25
4960.00	56.30	135	1.4	H	-53.33	2.40	11.60	-44.13	-30	-14.13
4960.00	55.55	121	1.4	V	-53.01	2.40	11.60	-43.81	-30	-13.81
7440.00	57.43	360	1.9	H	-49.81	3.00	11.90	-40.91	-30	-10.91
7440.00	53.07	139	2.0	V	-52.32	3.00	11.90	-43.42	-30	-13.42

Note:

1. The worst case is GFSK of basic Bluetooth/ BLE mode.
2. For the margin less than 6dB points, per pre-scan, the RMS value is lower than Peak. So no recorded.



7.9 Receiver spurious emissions

7.9.1 Definition

Receiver spurious emissions are emissions at any frequency when the equipment is in receive mode.

7.9.2 Limit

The spurious emissions of the receiver shall not exceed the values given in table 13.

In case of equipment with antenna connectors, these limits apply to emissions at the antenna port (conducted). For emissions radiated by the cabinet or for emissions radiated by integral antenna equipment (without antenna connectors), these limits are e.r.p. for emissions up to 1 GHz and e.i.r.p. for emissions above 1 GHz. Table 13: Spurious emission limits for receivers

Frequency range	Maximum power e.r.p. (≤ 1 GHz)	Measurement bandwidth
	e.i.r.p. (> 1 GHz)	
30 MHz to 1 GHz	-57 dBm	100 kHz
1 GHz to 12.75 GHz	-47 dBm	1 MHz

7.9.3 EUT Operation Condition

The EUT was programmed to be in continuously transmitting mode.

7.9.4 Test Procedure

The test site as described in annex B and applicable measurement procedures as described in annex C shall be used.

The test procedure is further as described under clause 5.4.10.2.1.



7.9.5 Test Result

Test Condition: Normal Mode: GFSK of basic Bluetooth Low channel										
Frequency	Receiver Reading	Turn table Angle	RX Antenna		Substituted			Absolute Level	Limit	Margin
			Height	Polar	SG Level	Cable	Antenna Gain			
(MHz)	(dBμV)	Degree	(m)	(H/V)	(dBm)	(dB)	(dB)	(dBm)	(dBm)	(dB)
253.34	42.68	202	1.7	H	-67.03	0.15	0.00	-67.18	-57	-10.18
253.34	40.50	157	1.7	V	-66.49	0.15	0.00	-66.64	-57	-9.64
2219.28	39.81	301	1.3	H	-73.57	0.34	10.50	-63.41	-47	-16.41
2219.28	39.56	78	1.1	V	-73.07	0.34	10.50	-62.91	-47	-15.91
Test Condition: Normal Mode: GFSK of basic Bluetooth High channel										
Frequency	Receiver Reading	Turn table Angle	RX Antenna		Substituted			Absolute Level	Limit	Margin
			Height	Polar	SG Level	Cable	Antenna Gain			
(MHz)	(dBμV)	Degree	(m)	(H/V)	(dBm)	(dB)	(dB)	(dBm)	(dBm)	(dB)
253.34	43.39	237	1.3	H	-66.32	0.15	0.00	-66.47	-57	-9.47
253.34	40.36	312	1.5	V	-66.63	0.15	0.00	-66.78	-57	-9.78
2219.28	39.08	258	1.4	H	-74.30	0.34	10.50	-64.14	-47	-17.14
2219.28	39.10	10	1.3	V	-73.53	0.34	10.50	-63.37	-47	-16.37

Note: The worst case is GFSK of basic Bluetooth mode.



8 Photographs of test setup and EUT.

Note: Please refer to appendix: Appendix-MO9838-Photos.

=====End of Report=====

WALTEK



中国认可
国际互认
检测
TESTING
CNAS L3110



TEST REPORT

Reference No. : WTF21D08089120W002
Manufacturer* : Mid Ocean Brands B.V.
Address : 7/F., Kings Tower, 111 King Lam Street, Cheung Sha Wan, Kowloon, Hong Kong
Factory : 110075
Product : TWS earbuds with charging base
Model(s) : MO9838
Standards : EN 62479: 2010
EN 50663: 2017
Date of Receipt sample : 2021-09-07
Date of Test : 2021-09-07 to 2021-09-15
Date of Issue : 2021-09-30
Test Result : **Pass**

Remarks:

1. The results shown in this test report refer only to the sample(s) tested, this test report cannot be reproduced, except in full, without prior written permission of the company. The report would be invalid without specific stamp of test institute and the signatures of compiler and approver.
2. "*" **manufacturer** means any natural or legal person who manufactures radio equipment or has radio equipment designed or manufactured, and markets that equipment under his name or trade mark.

Prepared By:
Waltek Testing Group Co., Ltd.

Address: No. 77, Houjie Section, Guantai Road, Houjie Town, Dongguan City, Guangdong, China
Tel: +86-769-2267 6998
Fax: +86-769-2267 6828

Compiled by:

Approved by:

Andy Feng / Project Engineer

Ford Wang / Designated Reviewer



2 Contents

	Page
1 COVER PAGE.....	1
2 CONTENTS.....	2
3 REVISION HISTORY.....	3
4 GENERAL INFORMATION.....	4
4.1 GENERAL DESCRIPTION OF E.U.T.....	4
4.2 DETAILS OF E.U.T.....	4
5 TEST SUMMARY.....	5
6 HEALTH REQUIREMENTS.....	6
6.1 LIMITS.....	6
6.2 TEST RESULT OF RF EXPOSURE EVALUATION.....	6
7 PHOTOGRAPHS OF TEST SETUP AND EUT.....	7

WALTEK



3 Revision History

Test report No.	Date of Receipt sample	Date of Test	Date of Issue	Purpose	Comment	Approved
WTF21D08089120 W002	2021-09-07	2021-09-07 to 2021-09-15	2021-09-30	Original	-	Valid

WALTEK



4 General Information

4.1 General Description of E.U.T.

Product.....: TWS earbuds with charging base

Model(s).....: MO9838

Model Description.....: N/A

Bluetooth Version.....: Bluetooth v5.0

Hardware Version.....: V1.1

Software Version.....: BAB5_NTC

4.2 Details of E.U.T.

Operation Frequency.....: Bluetooth: 2402-2480MHz

Max. RF output power.....: Basic Bluetooth: -0.47dBm

Type of Modulation.....: Bluetooth: GFSK, Pi/4 DQPSK, 8DPSK

Antenna installation.....: Bluetooth: internal permanent antenna

Antenna Gain.....: Bluetooth: 0dBi

Ratings.....: Input: charging base: 5V , 400mA (battery: 3.7V, 400mAh)
Earbuds: 5V , 35mA (battery: 3.7V, 35mAh*2)

WALTEK



5 Test Summary

HEALTH PART		
Test Items	Test Requirement	Result
RF Exposure	EN 62479 and EN 50663	PASS
Remark: N/A: Not Applicable RF: In this whole report RF means Radio Frequency.		

WALTEK



6 Health Requirements

6.1 Limits

According to Council Recommendation: the criteria listed in the following table shall be used to evaluate the environment impact of human exposure to radio frequency (RF) radiation.

Reference levels for electric, magnetic and electromagnetic fields (10MHz to 300GHz)

Low-power electronic and electrical equipment is deemed to comply with the provisions of this standard if it can be demonstrated using routes B, C or D that the available antenna power and/or the average total radiated power is less than or equal to the applicable low-power exclusion level Pmax.

Annex A contains example values for Pmax derived from existing exposure limits listed in the bibliography, such as the ICNIRP guidelines [1], IEEE Std C95.1-1999 [2], and IEEE Std C95.1-2005 [3].

For wireless devices operated close to a person's body with available antenna powers and/or average total radiated powers higher than the Pmax values given in Annex A, the alternative Pmax values (called Pmax'), described in Annex B can also be used.

For low power equipment using pulsed signals, other limits may apply in addition to those considered in Annex A and Annex B. Both ICNIRP guidelines [1] and IEEE standards [2], [3] have specific restrictions on exposures to pulsed fields, and the requirements of those standards with respect to exposure to pulses shall be met. Annex C discusses this topic further.

6.2 Test Result of RF Exposure Evaluation

Test Mode	Transmit
Limit (Pmax)	20mW/13dBm

Note: Only the receiving function, without testing can meet the requirements

After performed the test at low/middle/high channel, the below recorded is the worst.

Mode	The worst e.i.r.p. (dBm)	Pmax(dBm)	Result
Basic Bluetooth	-0.47	13	complies



7 Photographs of test setup and EUT.

Note: Please refer to appendix: Appendix- MO9838-Photos.

=====End of Report=====

WALTEK

CO., LTD.