EMC Test Report

Report No.: AGC05443230802EE01

PRODUCT DESIGNATION : 8 Digit bamboo calculator
BRAND NAME : N/A
MODEL NAME : M06215
APPLICANT : MID OCEAN BRANDS B.V
DATE OF ISSUE : Aug. 08, 2023
STANDARD(S) : EN 55032:2015/A11:2020
: EN 55035:2017/A11:2020
REPORT VERSION : V1.0

Attestation of Global Compliance(Shenzhen) Co., Ltd



Any report having not been signed by authorized approver, or having been altered without authorization, or having not been stamped by the "Dedicated Testing/Inspection Stamp" is deemed to be invalid. Copying or excerpting portion of, or altering the content of the report is not permitted without the written authorization of AGC. The test results presented in the report apply only to the tested sample. Any objections to report issued by AGC should be submitted to AGC within 15days after the issuance of the test report. Further enquiry of validity or verification of the test report should be addressed to AGC by agc01@agccert.com.

Attestation of Global Compliance(Shenzhen)Co., Ltd
Attestation of Global Compliance(Shenzhen)Std & Tech Co., Ltd
Tel: +86-755 2523 4088 E-mail: agc@agccert.com Web: <http://www.agccert.com/>



Report Revise Record

Report Version	Revise Time	Issued Date	Valid Version	Notes
V1.0	/	Aug. 08, 2023	Valid	Initial release

Any report having not been signed by authorized approver, or having been altered without authorization, or having not been stamped by the "Dedicated Testing/Inspection Stamp" is deemed to be invalid. Copying or excerpting portion of, or altering the content of the report is not permitted without the written authorization of AGC. The test results presented in the report apply only to the tested sample. Any objections to report issued by AGC should be submitted to AGC within 15days after the issuance of the test report. Further enquiry of validity or verification of the test report should be addressed to AGC by agc01@agccert.com.

TABLE OF CONTENTS

1. VERIFICATION OF CONFORMITY	4
2. SYSTEM DESCRIPTION	5
3. MEASUREMENT UNCERTAINTY	5
4. PRODUCT INFORMATION	6
5. SUPPORT EQUIPMENT	7
6. TEST FACILITY	8
7. TEST EQUIPMENT LIST	8
8. TEST SUMMARY LIST	9
9. EN 55032 RADIATED EMISSION TEST	10
9.1. LIMITS OF RADIATED DISTURBANCES.....	10
9.2. BLOCK DIAGRAM OF TEST SETUP.....	10
9.3. PROCEDURE OF RADIATED EMISSION TEST	11
9.4. TEST RESULT OF RADIATED EMISSION TEST	12
10. EN 61000-4-2 ESD IMMUNITY TEST	14
10.1. BLOCK DIAGRAM OF TEST SETUP.....	14
10.2. TEST PROCEDURE	16
10.3. PERFORMANCE & RESULT	17
11. EN 61000-4-3 RS IMMUNITY TEST	18
11.1. BLOCK DIAGRAM OF TEST SETUP.....	18
11.2. TEST PROCEDURE.....	19
11.3. PERFORMANCE & RESULT	19
APPENDIX I: PHOTOGRAPHS OF TEST SETUP	20
APPENDIX II: PHOTOGRAPHS OF EUT	22

Any report having not been signed by authorized approver, or having been altered without authorization, or having not been stamped by the “Dedicated Testing/Inspection Stamp” is deemed to be invalid. Copying or excerpting portion of, or altering the content of the report is not permitted without the written authorization of AGC. The test results presented in the report apply only to the tested sample. Any objections to report issued by AGC should be submitted to AGC within 15days after the issuance of the test report. Further enquiry of validity or verification of the test report should be addressed to AGC by agc01@agccert.com.

1. VERIFICATION OF CONFORMITY

Applicant	MID OCEAN BRANDS B.V
Address	7/F, Kings Tower, 111 King Lam Street, Cheung Sha Wan, Kowloon, Hong Kong
Manufacturer	MID OCEAN BRANDS B.V
Address	7/F, Kings Tower, 111 King Lam Street, Cheung Sha Wan, Kowloon, Hong Kong
Factory	MID OCEAN BRANDS B.V
Address	7/F, Kings Tower, 111 King Lam Street, Cheung Sha Wan, Kowloon, Hong Kong
Product Designation	8 Digit bamboo calculator
Brand Name	N/A
Test Model	MO6215
Date of receipt of test item	Aug. 04, 2023
Date of test	Aug. 04, 2023 to Aug. 08, 2023
Deviation	No deviation from the test method.
Condition of Test Sample	Normal
Test Result	Pass

The above equipment was tested by Attestation of Global Compliance(Shenzhen) Co., Ltd. for compliance with the requirements set forth in the Technical Standards mentioned above. This said equipment in the configuration described in this report shows the maximum emission levels emanating from equipment and the level of the immunity endurance of the equipment are within the compliance requirements.

The test results of this report relate only to the tested sample identified in this report.

Prepared By 

 Jack Gui
 (Project Engineer) Aug. 08, 2023

Reviewed By 

 Calvin Liu
 (Reviewer) Aug. 08, 2023

Approved By 

 Max Zhang
 (Authorized Officer) Aug. 08, 2023

Any report having not been signed by authorized approver, or having been altered without authorization, or having not been stamped by the “Dedicated Testing/Inspection Stamp” is deemed to be invalid. Copying or excerpting portion of, or altering the content of the report is not permitted without the written authorization of AGC. The test results presented in the report apply only to the tested sample. Any objections to report issued by AGC should be submitted to AGC within 15days after the issuance of the test report. Further enquiry of validity or verification of the test report should be addressed to AGC by agc01@agccert.com.

2. SYSTEM DESCRIPTION

TEST MODE DESCRIPTION		
NO.	TEST MODE DESCRIPTION	WORST
1	Normal operation	--

3. MEASUREMENT UNCERTAINTY

The uncertainty is calculated using the methods suggested in the “Guide to the Expression of Uncertainty in measurement” (GUM) published by ISO.

- Uncertainty of Radiated Emission, $U_c = \pm 3.9$ dB

Any report having not been signed by authorized approver, or having been altered without authorization, or having not been stamped by the “Dedicated Testing/Inspection Stamp” is deemed to be invalid. Copying or excerpting portion of, or altering the content of the report is not permitted without the written authorization of AGC. The test results presented in the report apply only to the tested sample. Any objections to report issued by AGC should be submitted to AGC within 15days after the issuance of the test report. Further enquiry of validity or verification of the test report should be addressed to AGC by agc01@agccert.com.

Attestation of Global Compliance(Shenzhen)Co., Ltd
Attestation of Global Compliance(Shenzhen)Std & Tech Co., Ltd
Tel: +86-755 2523 4088 E-mail: agc@agccert.com Web: <http://www.agccert.com/>

4. PRODUCT INFORMATION

Housing Type	Plastics and wood
EUT Power supply	DC 1.5V by battery
Hardware Version	N/A
Software Version	N/A

I/O Port Information (Applicable Not Applicable)

I/O Port of EUT			
I/O Port Type	Number	Cable Description	Tested With
--	--	--	--

Any report having not been signed by authorized approver, or having been altered without authorization, or having not been stamped by the “Dedicated Testing/Inspection Stamp” is deemed to be invalid. Copying or excerpting portion of, or altering the content of the report is not permitted without the written authorization of AGC. The test results presented in the report apply only to the tested sample. Any objections to report issued by AGC should be submitted to AGC within 15days after the issuance of the test report. Further enquiry of validity or verification of the test report should be addressed to AGC by agc01@agccert.com.

5. SUPPORT EQUIPMENT

Device Type	Manufacturer	Model Name	Serial No.	Data Cable	Power Cable
--	--	--	--	--	--

Note: "--" means no any support device during testing.

Any report having not been signed by authorized approver, or having been altered without authorization, or having not been stamped by the "Dedicated Testing/Inspection Stamp" is deemed to be invalid. Copying or excerpting portion of, or altering the content of the report is not permitted without the written authorization of AGC. The test results presented in the report apply only to the tested sample. Any objections to report issued by AGC should be submitted to AGC within 15days after the issuance of the test report. Further enquiry of validity or verification of the test report should be addressed to AGC by agc01@agccert.com.

Attestation of Global Compliance(Shenzhen)Co., Ltd
Attestation of Global Compliance(Shenzhen)Std & Tech Co., Ltd
Tel: +86-755 2523 4088 E-mail: agc@agccert.com Web: <http://www.agccert.com/>

6. TEST FACILITY

Site	Attestation of Global Compliance (Shenzhen) Co., Ltd
Location	1-2/F, Building 19, Junfeng Industrial Park, Chongqing Road, Heping Community, Fuhai Street, Bao 'an District, Shenzhen, Guangdong, China

7. TEST EQUIPMENT LIST

TEST EQUIPMENT OF RADIATED EMISSION TEST

Equipment	Manufacturer	Model	S/N	Cal. Date	Cal. Due
Test Receiver	R&S	ESCI	10096	Feb. 18, 2023	Feb. 17, 2024
Wideband Antenna	SCHWARZBECK	VULB9168	D69250	May 11, 2023	May 10, 2025
Test software	FARA	EZ-EMC	Ver.RA-03A	N/A	N/A

TEST EQUIPMENT OF ESD TEST

Equipment	Manufacturer	Model	S/N	Cal. Date	Cal. Due
ESD Simulator	Schaffner	NSG 438	782	Dec. 30, 2022	Dec. 29, 2023

TEST EQUIPMENT OF RS IMMUNITY TEST

Equipment	Manufacturer	Model	S/N	Cal. Date	Cal. Due
Signal Generator	AGILENT	N5182A	MY50140530	Feb. 17, 2023	Feb. 16, 2024
Power Sensor	R&S	URV5-Z4	100124	Mar. 24, 2023	Mar. 23, 2025
Power Meter	R&S	NRVD	8323781027	Mar. 24, 2023	Mar. 23, 2025
Power Amplifier	KALMUS	7100LC	04-02/17-06-001	N/A	N/A
Power Amplifier	Milmega	AS0104-55_55	1004793	N/A	N/A
Power Amplifier	rflight	NTWPA-2560100	17063183	N/A	N/A
Antenna	SCHWARZBECK	VULB9168	D69250	May 11, 2023	May 10, 2025
Test software	Tonscend	2.0.1.8	N/A	N/A	N/A

Any report having not been signed by authorized approver, or having been altered without authorization, or having not been stamped by the "Dedicated Testing/Inspection Stamp" is deemed to be invalid. Copying or excerpting portion of, or altering the content of the report is not permitted without the written authorization of AGC. The test results presented in the report apply only to the tested sample. Any objections to report issued by AGC should be submitted to AGC within 15days after the issuance of the test report. Further enquiry of validity or verification of the test report should be addressed to AGC by agc01@agccert.com.

8. TEST SUMMARY LIST

Test item	Test Requirement	Test Method	Class/Severity	Result
Conducted emission	EN 55032	EN 55032	Class B	N/A
Radiated emission	EN 55032	EN 55032	Class B	Pass
Harmonic current emission	EN IEC 61000-3-2	EN IEC 61000-3-2	Class A	N/A
Voltage fluctuations & flicker	EN 61000-3-3	EN 61000-3-3	§5 of EN 61000-3-3	N/A
Electrostatic discharge immunity	EN 55035	EN 61000-4-2	± 8.0 kV (Air Discharge) ± 4.0 kV (Contact Discharge) ± 4.0 kV (Indirect Discharge)	Pass
Radiated electromagnetic field immunity	EN 55035	EN 61000-4-3	3V/m with 80% AM. 1kHz Modulation.	Pass
Electrical fast transient/burst Immunity	EN 55035	EN 61000-4-4	+/- 1kV for Power Supply Lines	N/A
Surge immunity	EN 55035	EN 61000-4-5	+/- 1kV (Line to Line) +/- 2kV (Line to Ground)	N/A
Immunity to Conducted Disturbances Induced by RF fields	EN 55035	EN 61000-4-6	3V(0.15MHz-10MHz) 3V-1V(10MHz-30MHz) 1V(30MHz-80MHz) with 80% AM. 1 kHz Modulation	N/A
Power frequency magnetic field	EN 55035	EN61000-4-8	1A/m 50Hz or 60Hz	N/A
Voltage dips and short interruptions immunity	EN 55035	EN 61000-4-11	0degrees	N/A

Note: N/A means not applicable.

Any report having not been signed by authorized approver, or having been altered without authorization, or having not been stamped by the "Dedicated Testing/Inspection Stamp" is deemed to be invalid. Copying or excerpting portion of, or altering the content of the report is not permitted without the written authorization of AGC. The test results presented in the report apply only to the tested sample. Any objections to report issued by AGC should be submitted to AGC within 15days after the issuance of the test report. Further enquiry of validity or verification of the test report should be addressed to AGC by agc01@agccert.com.

9. EN 55032 RADIATED EMISSION TEST

9.1. LIMITS OF RADIATED DISTURBANCES

Limits for radiated disturbance 30M to1 GHz at a measurement distance of 3 m

Frequency range (MHz)	Quasi peak limits(dBuV/m), for Class B ITE, at 3m measurement distance
30 - 230	40
230 - 1000	47

Limits for radiated disturbance above 1 GHz at a measurement distance of 3 m

Frequency range (MHz)	Limits (dBuV/m), Class B ITE	
	Peak	Average
1000-3000	70	50
3000-6000	74	54

Notes:

1. The lower limit shall apply at the transition frequency.
2. Additional provisions may be required for cases where interference occurs.

9.2. BLOCK DIAGRAM OF TEST SETUP

System Diagram of Connections between EUT and Simulators

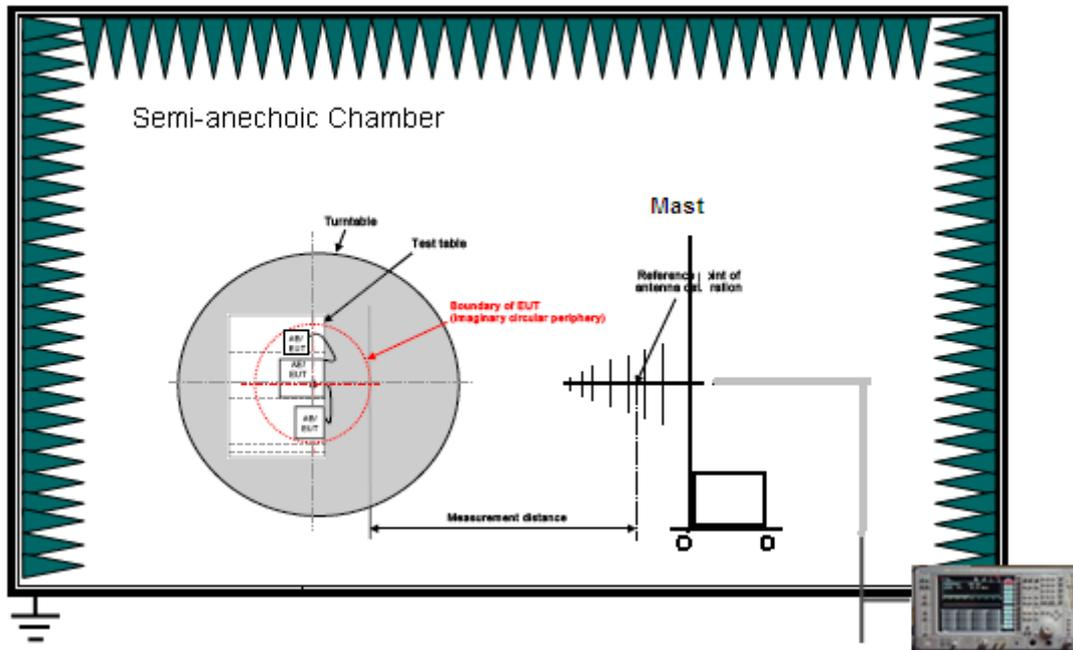

Any report having not been signed by authorized approver, or having been altered without authorization, or having not been stamped by the "Dedicated Testing/Inspection Stamp" is deemed to be invalid. Copying or excerpting portion of, or altering the content of the report is not permitted without the written authorization of AGC. The test results presented in the report apply only to the tested sample. Any objections to report issued by AGC should be submitted to AGC within 15days after the issuance of the test report. Further enquiry of validity or verification of the test report should be addressed to AGC by agc01@agccert.com.

9.3. PROCEDURE OF RADIATED EMISSION TEST

- (1) The equipment was set up as per the test configuration to simulate typical actual usage per the user's manual. When the EUT is a tabletop system, a wooden turntable with a height of 0.8 meters is used which is placed on the ground plane as per EN 55032 (see Test Facility for the dimensions of the ground plane used). When the EUT is a floor-standing equipment, it is placed on the ground plane which has a 10cm non-conductive covering to insulate the EUT from the ground plane.
- (2) Support equipment, if needed, was placed as per EN 55032.
- (3) All I/O cables were positioned to simulate typical actual usage as per EN 55032.
- (4) The EUT was turned on.
- (5) The antenna was placed at 3 meter away from the EUT as stated in EN 55032. The antenna connected to the Analyzer via a cable and at times a pre-amplifier would be used.
- (6) The Analyzer / Receiver quickly scanned from 30MHz to 1000MHz. The EUT test program was started. Emissions were scanned and measured rotating the EUT to 360 degrees and positioning the antenna 1 to 4 meters above the ground plane, in both the vertical and the horizontal polarization, to maximize the emission reading level.
- (7) The test mode(s) were scanned during the test:
- (8) Recorded at least the six highest emissions. Emission frequency, amplitude, antenna position, polarization and turntable position were recorded into a computer in which correction factors were used to calculate the emission level and compare reading to the applicable limit and Q.P./Peak reading is presented.

Any report having not been signed by authorized approver, or having been altered without authorization, or having not been stamped by the "Dedicated Testing/Inspection Stamp" is deemed to be invalid. Copying or excerpting portion of, or altering the content of the report is not permitted without the written authorization of AGC. The test results presented in the report apply only to the tested sample. Any objections to report issued by AGC should be submitted to AGC within 15days after the issuance of the test report. Further enquiry of validity or verification of the test report should be addressed to AGC by agc01@agccert.com.

9.4. TEST RESULT OF RADIATED EMISSION TEST

Radiated Emission Test at 3m Distance-Horizontal

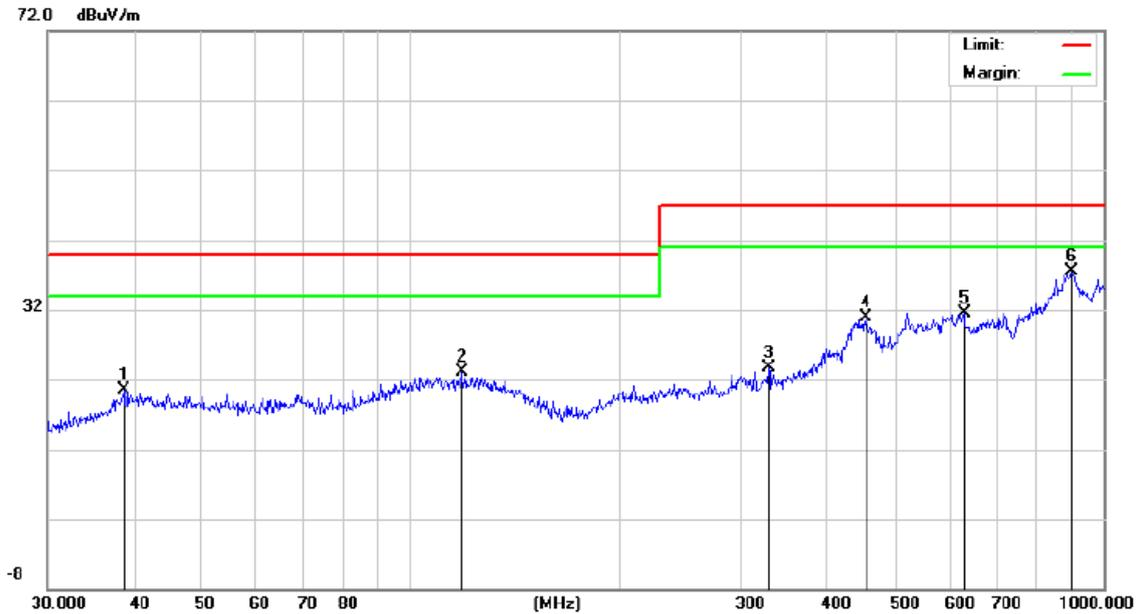

No.	Mk.	Freq. MHz	Reading Level dBuV	Correct Factor dB	Measure- ment dBuV/m	Limit dB/m	Over dB	Detector
1		38.6160	7.23	13.30	20.53	40.00	-19.47	peak
2		118.6014	6.75	16.39	23.14	40.00	-16.86	peak
3		329.0390	7.00	16.77	23.77	47.00	-23.23	peak
4		454.3100	6.39	24.60	30.99	47.00	-16.01	peak
5		629.4772	7.11	24.30	31.41	47.00	-15.59	peak
6	*	900.1474	5.77	31.78	37.55	47.00	-9.45	peak

RESULT: PASS

Any report having not been signed by authorized approver, or having been altered without authorization, or having not been stamped by the "Dedicated Testing/Inspection Stamp" is deemed to be invalid. Copying or excerpting portion of, or altering the content of the report is not permitted without the written authorization of AGC. The test results presented in the report apply only to the tested sample. Any objections to report issued by AGC should be submitted to AGC within 15days after the issuance of the test report. Further enquiry of validity or verification of the test report should be addressed to AGC by agc01@agccert.com.

Radiated Emission Test at 3m Distance-Vertical

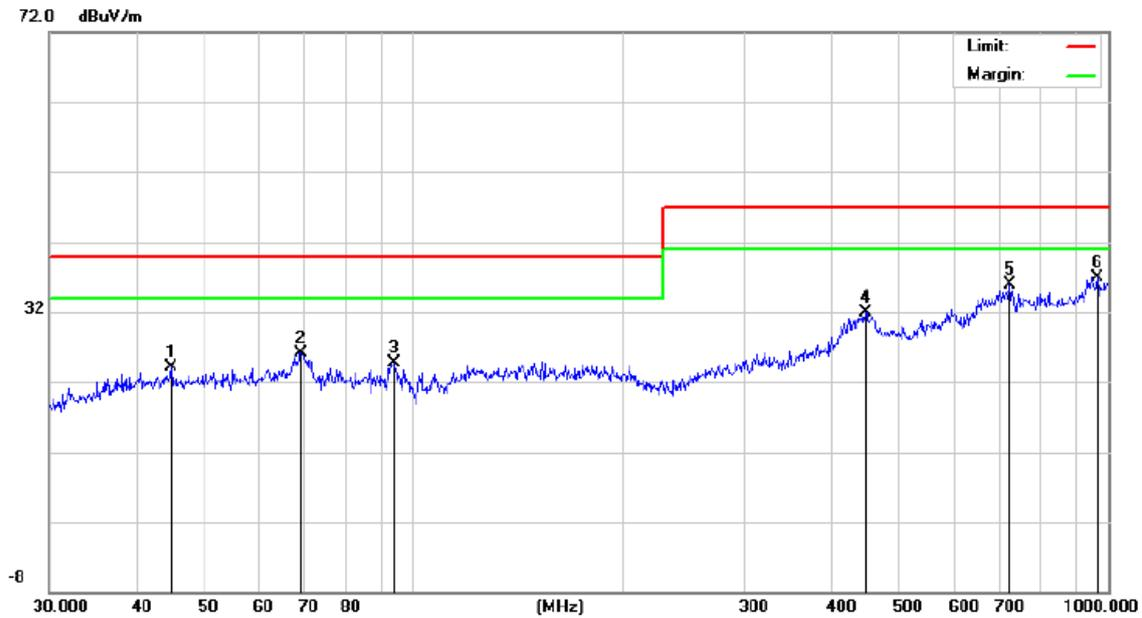

No.	Mk.	Freq. MHz	Reading Level dBuV	Correct Factor dB	Measure- ment dBuV/m	Limit dB/m	Over dB	Detector
1		44.9006	7.11	16.95	24.06	40.00	-15.94	peak
2		69.1141	9.12	17.01	26.13	40.00	-13.87	peak
3		94.0979	9.76	15.00	24.76	40.00	-15.24	peak
4		447.9822	6.25	25.74	31.99	47.00	-15.01	peak
5		721.7259	7.24	28.64	35.88	47.00	-11.12	peak
6	*	965.5421	7.01	29.95	36.96	47.00	-10.04	peak

RESULT: PASS

Note:

$$\text{Level(dBuV/m)} = \text{Reading(dBuV)} + \text{Factor(dB/m)}$$

$$\text{Factor(dB/m)} = \text{Antenna Factor(dB/m)} + \text{Cable loss(dB)} + \text{Attenuation(dB) for Attenuator}$$

$$\text{Over} = \text{Measurement} - \text{Limit}$$

Any report having not been signed by authorized approver, or having been altered without authorization, or having not been stamped by the "Dedicated Testing/Inspection Stamp" is deemed to be invalid. Copying or excerpting portion of, or altering the content of the report is not permitted without the written authorization of AGC. The test results presented in the report apply only to the tested sample. Any objections to report issued by AGC should be submitted to AGC within 15days after the issuance of the test report. Further enquiry of validity or verification of the test report should be addressed to AGC by agc01@agccert.com.

10. EN 61000-4-2 ESD IMMUNITY TEST
ELECTROSTATIC DISCHARGE (ESD) IMMUNITY TEST

Port	Enclosure
Basic Standard	EN 61000-4-2
Test Level	± 8.0 kV (Air Discharge) ± 4.0 kV (Contact Discharge) ± 4.0 kV (Indirect Discharge)
Standard require	B
Temperature	23°C
Humidity	42% RH

10.1. BLOCK DIAGRAM OF TEST SETUP

(The 470 k ohm resistors are installed per standard requirement)

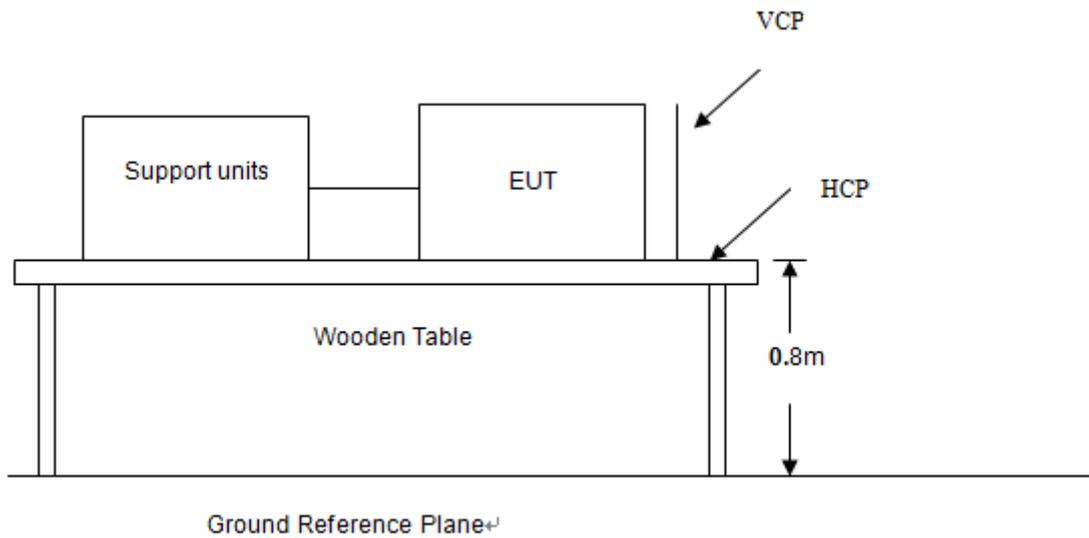

Any report having not been signed by authorized approver, or having been altered without authorization, or having not been stamped by the “Dedicated Testing/Inspection Stamp” is deemed to be invalid. Copying or excerpting portion of, or altering the content of the report is not permitted without the written authorization of AGC. The test results presented in the report apply only to the tested sample. Any objections to report issued by AGC should be submitted to AGC within 15days after the issuance of the test report. Further enquiry of validity or verification of the test report should be addressed to AGC by agc01@agccert.com.

ESD LOCATION:

Yellow line: Air discharge

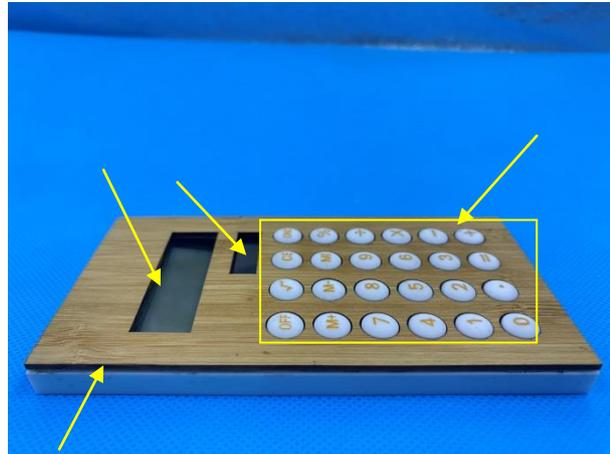
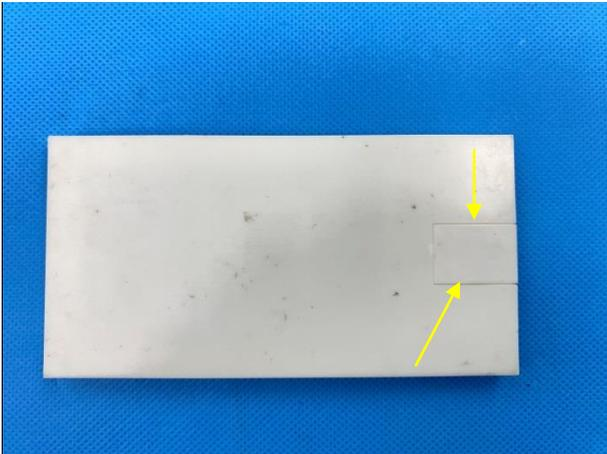

Note: Contact discharge point not found.

Any report having not been signed by authorized approver, or having been altered without authorization, or having not been stamped by the "Dedicated Testing/Inspection Stamp" is deemed to be invalid. Copying or excerpting portion of, or altering the content of the report is not permitted without the written authorization of AGC. The test results presented in the report apply only to the tested sample. Any objections to report issued by AGC should be submitted to AGC within 15days after the issuance of the test report. Further enquiry of validity or verification of the test report should be addressed to AGC by agc01@agccert.com.

10.2. TEST PROCEDURE

The test procedure shall be in accordance with EN 61000-4-2. Electrostatic discharges shall be applied only to points and surfaces of the EUT which are expected to be touched during normal operation, including user access operations specified in the user manual, for example cleaning or adding consumables when the EUT is powered. The application of discharges to the contacts of open connectors is not required.

The number of test points is EUT dependent. Subclause 8.3.1 and Clause A.5 of EN 61000-4-2 shall be taken into consideration when selecting test points, paying particular attention to keyboards, dialling pads, power switches, mice, drive slots, card slots, the areas around communication ports, etc.

When applying direct discharges to a portable or handheld battery-powered EUT with a display screen, it may not be possible to observe the screen for a given EUT orientation. If observation of the screen is necessary during this test, the EUT may be mounted vertically using non-metallic supports.

Note: As per the A2 to EN 61000-4-2, a bleed resistor cable is connected between the EUT and HCP during the test. The electrostatic discharges were applied as follows:

Voltage	Coupling	Test Performance	Result
±4kV	Contact Discharge	No function loss	N/A
±4kV	Indirect Discharge HCP (Front)	No function loss	A
±4kV	Indirect Discharge HCP (Left)	No function loss	A
±4kV	Indirect Discharge HCP (Back)	No function loss	A
±4kV	Indirect Discharge HCP (Right)	No function loss	A
±4kV	Indirect Discharge VCP (Front)	No function loss	A
±4kV	Indirect Discharge VCP (Left)	No function loss	A
±4kV	Indirect Discharge VCP (Back)	No function loss	A
±4kV	Indirect Discharge VCP (Right)	No function loss	A
±8kV	Air Discharge	No function loss	A

Any report having not been signed by authorized approver, or having been altered without authorization, or having not been stamped by the “Dedicated Testing/Inspection Stamp” is deemed to be invalid. Copying or excerpting portion of, or altering the content of the report is not permitted without the written authorization of AGC. The test results presented in the report apply only to the tested sample. Any objections to report issued by AGC should be submitted to AGC within 15days after the issuance of the test report. Further enquiry of validity or verification of the test report should be addressed to AGC by agc01@agccert.com.

10.3. PERFORMANCE & RESULT

Criteria A:	The apparatus continues to operate as intended. No degradation of performance or loss of function is allowed below a performance level specified by the manufacturer, when the apparatus is used as intended. In some cases the performance level may be replaced by a permissible loss of performance.
Criteria B:	The apparatus continues to operate as intended after the test. No degradation of performance or loss of function is allowed below a performance level specified by the manufacturer, when the apparatus is used as intended. In some cases the performance level may be replaced by a permissible loss of performance. During the test, degradation of performance is however allowed.
Criteria C:	Temporary loss of function is allowed, provided the functions self recoverable or can be restored by the operation of controls.

<input checked="" type="checkbox"/> PASS <input type="checkbox"/> FAIL
--

Any report having not been signed by authorized approver, or having been altered without authorization, or having not been stamped by the "Dedicated Testing/Inspection Stamp" is deemed to be invalid. Copying or excerpting portion of, or altering the content of the report is not permitted without the written authorization of AGC. The test results presented in the report apply only to the tested sample. Any objections to report issued by AGC should be submitted to AGC within 15days after the issuance of the test report. Further enquiry of validity or verification of the test report should be addressed to AGC by agc01@agccert.com.

11. EN 61000-4-3 RS IMMUNITY TEST

RADIATED ELECTROMAGNETIC FIELD IMMUNITY TEST

Port	Enclosure
Basic Standard	EN 61000-4-3
Test Level:	3V/m with 80% AM. 1kHz Modulation.
Standard require	A
Temperature	24.3°C
Humidity	61.5%RH

11.1. BLOCK DIAGRAM OF TEST SETUP

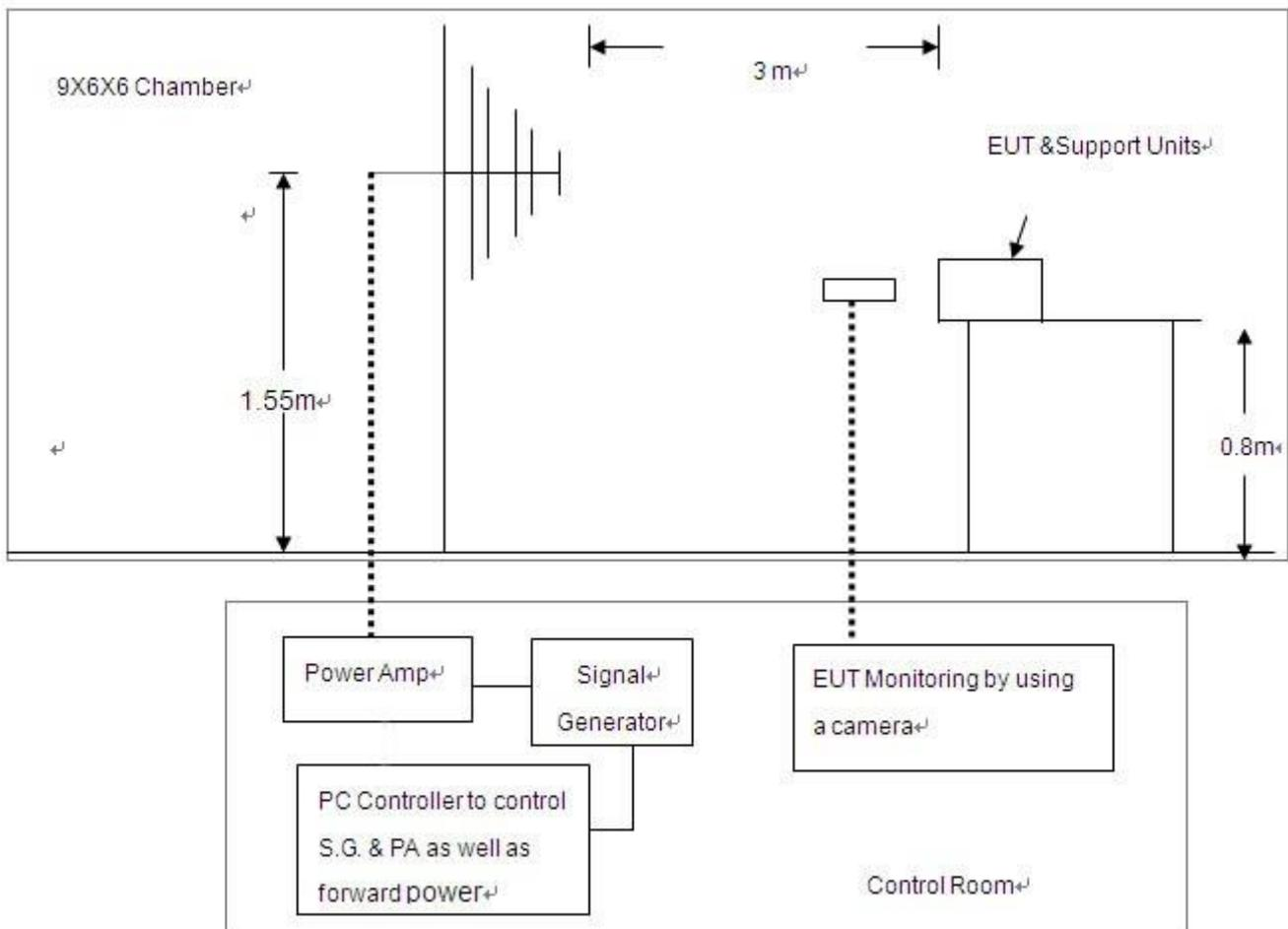

Any report having not been signed by authorized approver, or having been altered without authorization, or having not been stamped by the “Dedicated Testing/Inspection Stamp” is deemed to be invalid. Copying or excerpting portion of, or altering the content of the report is not permitted without the written authorization of AGC. The test results presented in the report apply only to the tested sample. Any objections to report issued by AGC should be submitted to AGC within 15days after the issuance of the test report. Further enquiry of validity or verification of the test report should be addressed to AGC by agc01@agccert.com.

11.2. TEST PROCEDURE

The EUT was located at the edge of supporting table keep 3 meter away from transmitting antenna, it just the calibrated square area of field uniformity. The support units were located outside of the uniformity area, but the cable(s) connected with EUT were exposed to the calibrated field as per EN 61000-4-3.

EUT worked with resistance load, and make sure EUT worked normally.

Setting the testing parameters of RS test software per EN 61000-4-3.

Performing the test at each side of with specified level (3V/m) at 1% steps and test frequency from 80MHz to 1000MHz

Recording the test result in following table.

EN 61000-4-3 Final test conditions:

Test level: 3V/m

Steps: 1 % of fundamental

Dwell Time: 1 sec

Range (MHz)	Field	Modulation	Polarity	Position	Test Performance	Result
80-1000	3V/m	AM	H/V	Front	No function loss	A
80-1000	3V/m	AM	H/V	Left	No function loss	A
80-1000	3V/m	AM	H/V	Back	No function loss	A
80-1000	3V/m	AM	H/V	Right	No function loss	A
1800,2600,3500,5000	3V/m	AM	H/V	Front	No function loss	A
1800,2600,3500,5000	3V/m	AM	H/V	Left	No function loss	A
1800,2600,3500,5000	3V/m	AM	H/V	Back	No function loss	A
1800,2600,3500,5000	3V/m	AM	H/V	Right	No function loss	A

Frequency (± 1 %) for Spot test.

11.3. PERFORMANCE & RESULT

Criteria A:	The apparatus continues to operate as intended. No degradation of performance or loss of function is allowed below a performance level specified by the manufacturer, when the apparatus is used as intended. In some cases the performance level may be replaced by a permissible loss of performance.
Criteria B:	The apparatus continues to operate as intended after the test. No degradation of performance or loss of function is allowed below a performance level specified by the manufacturer, when the apparatus is used as intended. In some cases the performance level may be replaced by a permissible loss of performance. During the test, degradation of performance is however allowed.
Criteria C:	Temporary loss of function is allowed, provided the functions self recoverable or can be restored by the operation of controls.

PASS

FAIL

Any report having not been signed by authorized approver, or having been altered without authorization, or having not been stamped by the "Dedicated Testing/Inspection Stamp" is deemed to be invalid. Copying or excerpting portion of, or altering the content of the report is not permitted without the written authorization of AGC. The test results presented in the report apply only to the tested sample. Any objections to report issued by AGC should be submitted to AGC within 15days after the issuance of the test report. Further enquiry of validity or verification of the test report should be addressed to AGC by agc01@agccert.com.

Attestation of Global Compliance(Shenzhen)Co., Ltd

Attestation of Global Compliance(Shenzhen)Std & Tech Co., Ltd

Tel: +86-755 2523 4088 E-mail: agc@agccert.com Web: http://www.agccert.com/

APPENDIX I: PHOTOGRAPHS OF TEST SETUP

EN 55032 RADIATED EMISSION TESTSETUP

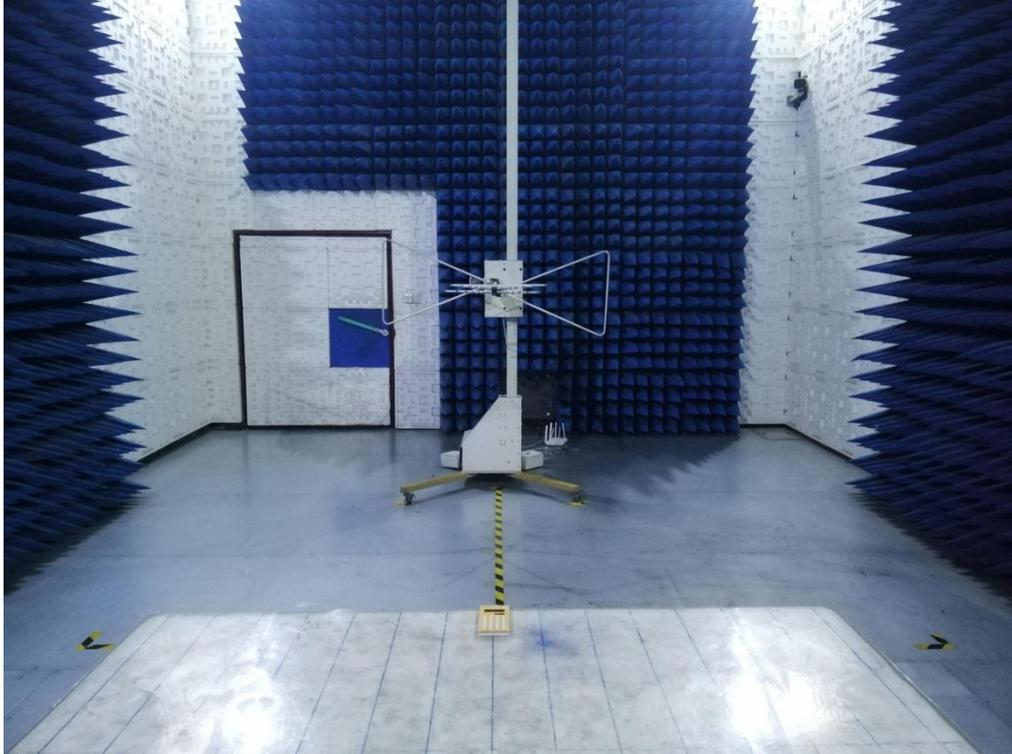

EN 61000-4-2 ESD IMMUNITY TEST SETUP

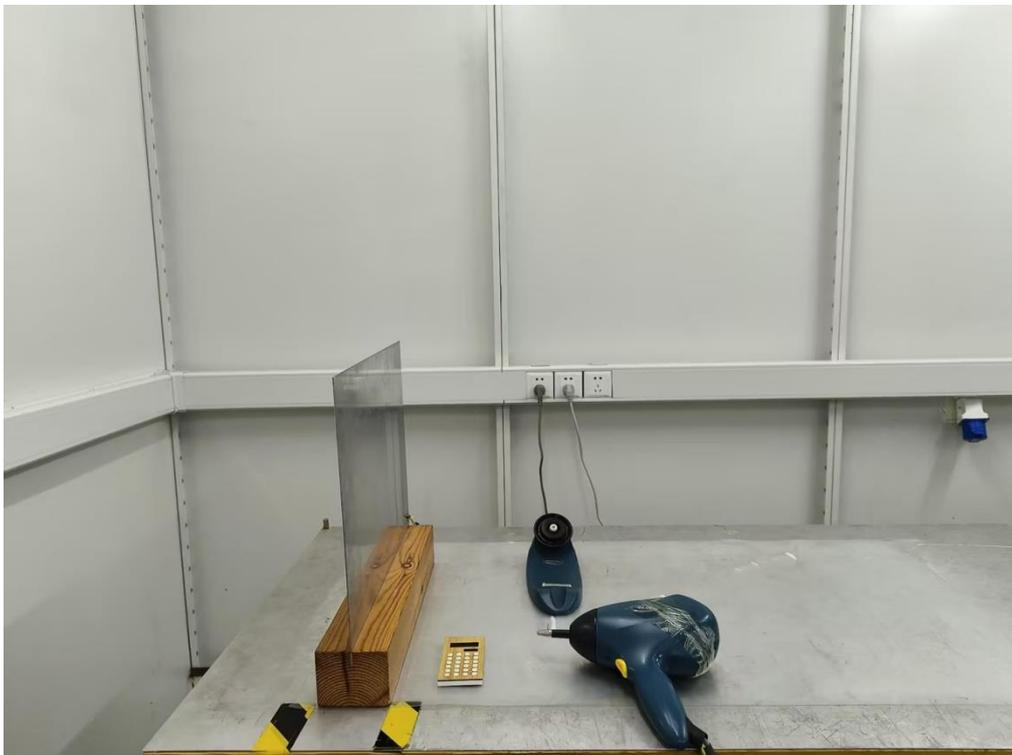

Any report having not been signed by authorized approver, or having been altered without authorization, or having not been stamped by the “Dedicated Testing/Inspection Stamp” is deemed to be invalid. Copying or excerpting portion of, or altering the content of the report is not permitted without the written authorization of AGC. The test results presented in the report apply only to the tested sample. Any objections to report issued by AGC should be submitted to AGC within 15days after the issuance of the test report. Further enquiry of validity or verification of the test report should be addressed to AGC by agc01@agccert.com.

EN 61000-4-3 RS IMMUNITY TEST SETUP

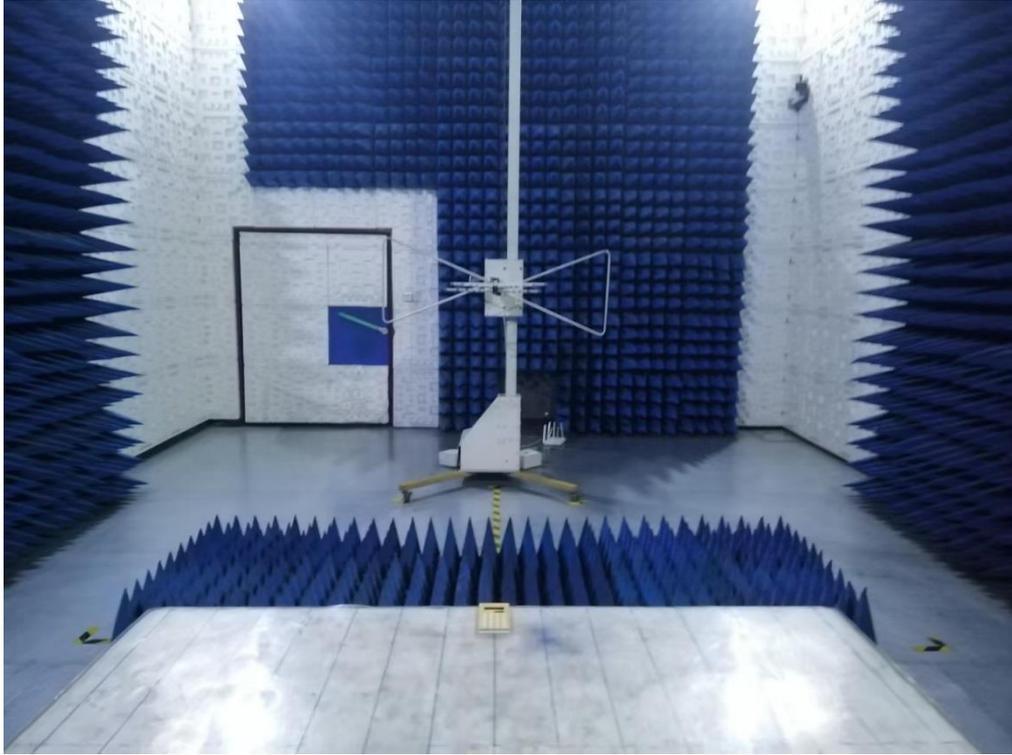

Any report having not been signed by authorized approver, or having been altered without authorization, or having not been stamped by the "Dedicated Testing/Inspection Stamp" is deemed to be invalid. Copying or excerpting portion of, or altering the content of the report is not permitted without the written authorization of AGC. The test results presented in the report apply only to the tested sample. Any objections to report issued by AGC should be submitted to AGC within 15days after the issuance of the test report. Further enquiry of validity or verification of the test report should be addressed to AGC by agc01@agccert.com.

APPENDIX II: PHOTOGRAPHS OF EUT

TOP VIEW OF EUT

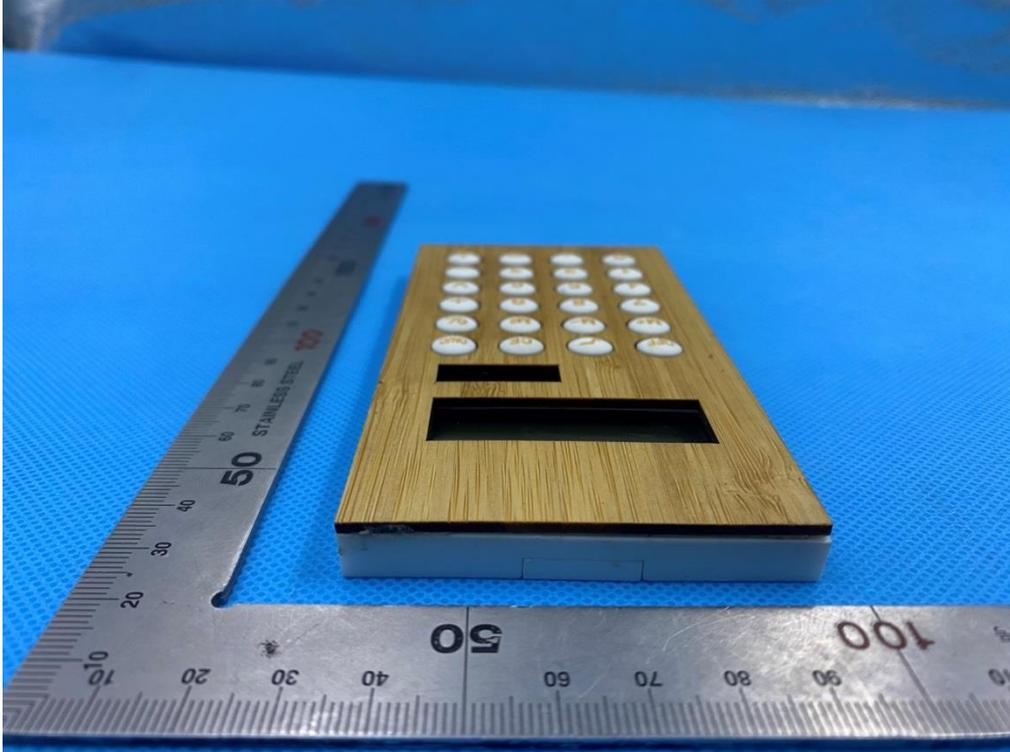

BOTTOM VIEW OF EUT

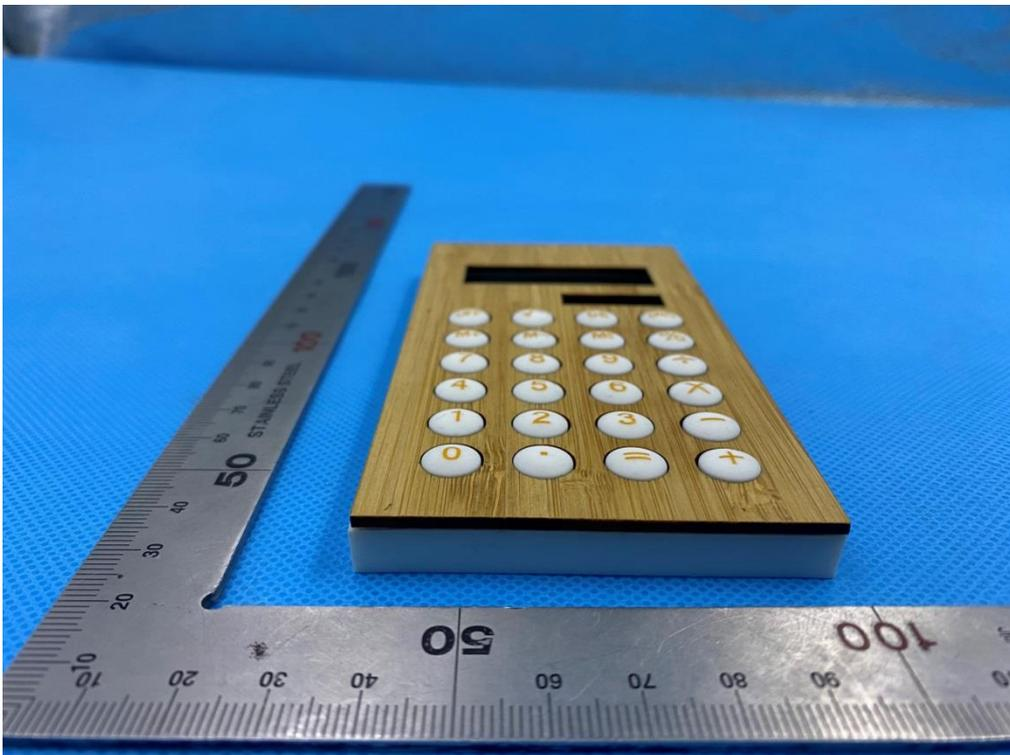

Any report having not been signed by authorized approver, or having been altered without authorization, or having not been stamped by the “Dedicated Testing/Inspection Stamp” is deemed to be invalid. Copying or excerpting portion of, or altering the content of the report is not permitted without the written authorization of AGC. The test results presented in the report apply only to the tested sample. Any objections to report issued by AGC should be submitted to AGC within 15days after the issuance of the test report. Further enquiry of validity or verification of the test report should be addressed to AGC by agc01@agccert.com.

FRONT VIEW OF EUT

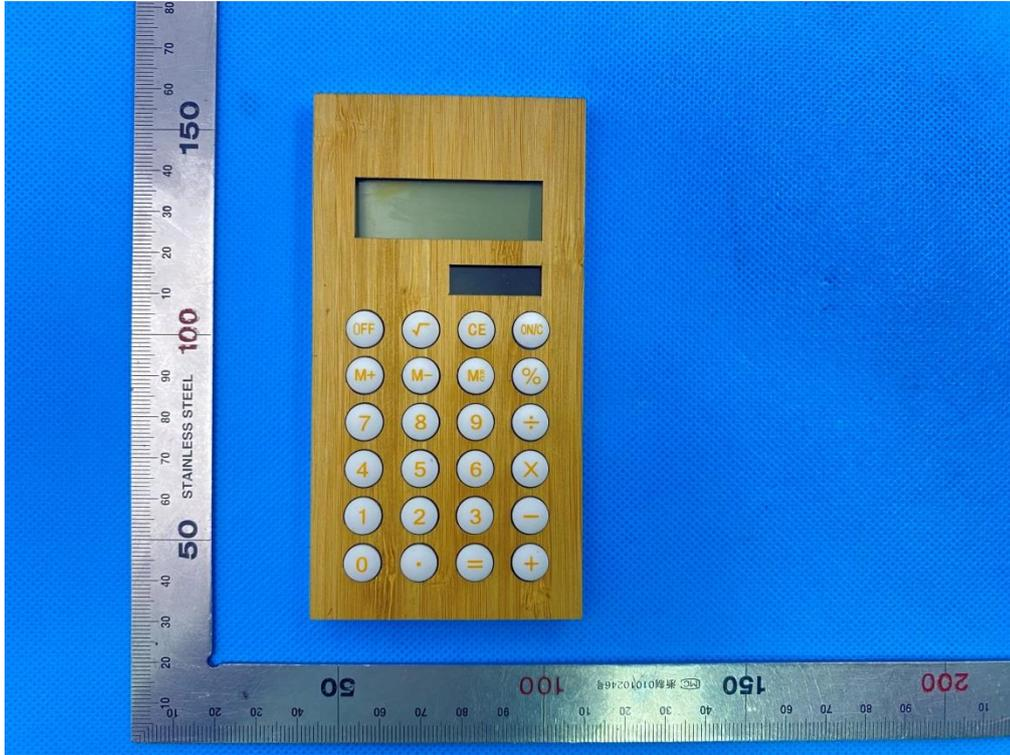

BACK VIEW OF EUT

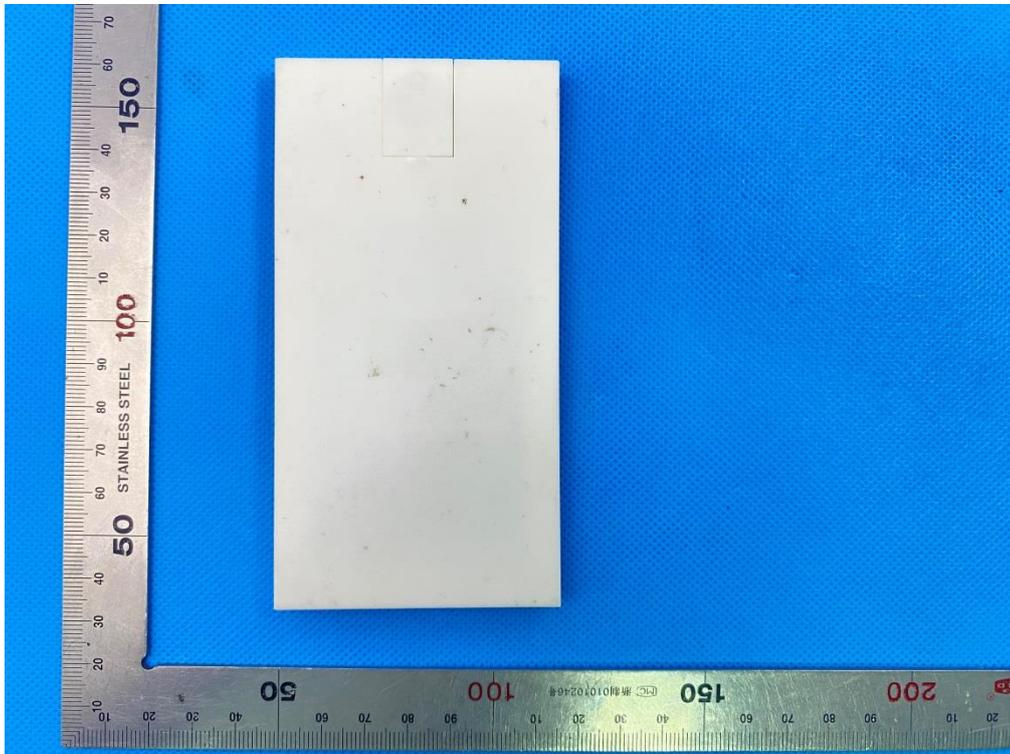

Any report having not been signed by authorized approver, or having been altered without authorization, or having not been stamped by the “Dedicated Testing/Inspection Stamp” is deemed to be invalid. Copying or excerpting portion of, or altering the content of the report is not permitted without the written authorization of AGC. The test results presented in the report apply only to the tested sample. Any objections to report issued by AGC should be submitted to AGC within 15days after the issuance of the test report. Further enquiry of validity or verification of the test report should be addressed to AGC by agc01@agccert.com.

LEFT VIEW OF EUT

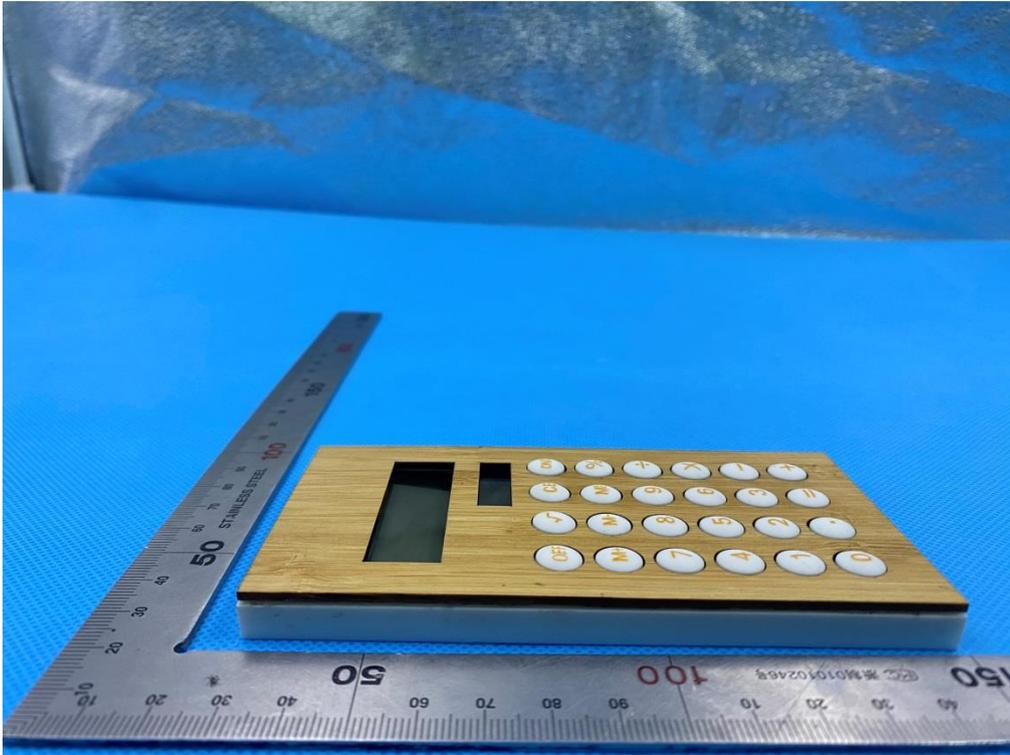

RIGHT VIEW OF EUT

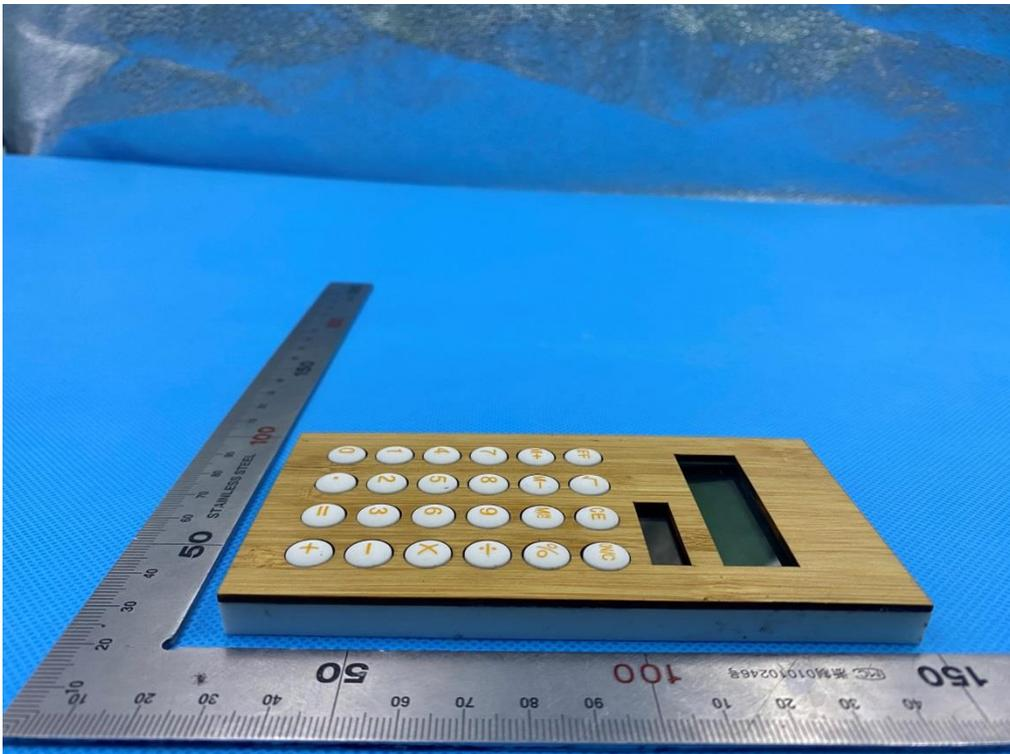

Any report having not been signed by authorized approver, or having been altered without authorization, or having not been stamped by the "Dedicated Testing/Inspection Stamp" is deemed to be invalid. Copying or excerpting portion of, or altering the content of the report is not permitted without the written authorization of AGC. The test results presented in the report apply only to the tested sample. Any objections to report issued by AGC should be submitted to AGC within 15days after the issuance of the test report. Further enquiry of validity or verification of the test report should be addressed to AGC by agc01@agccert.com.

OPEN VIEW OF EUT-1

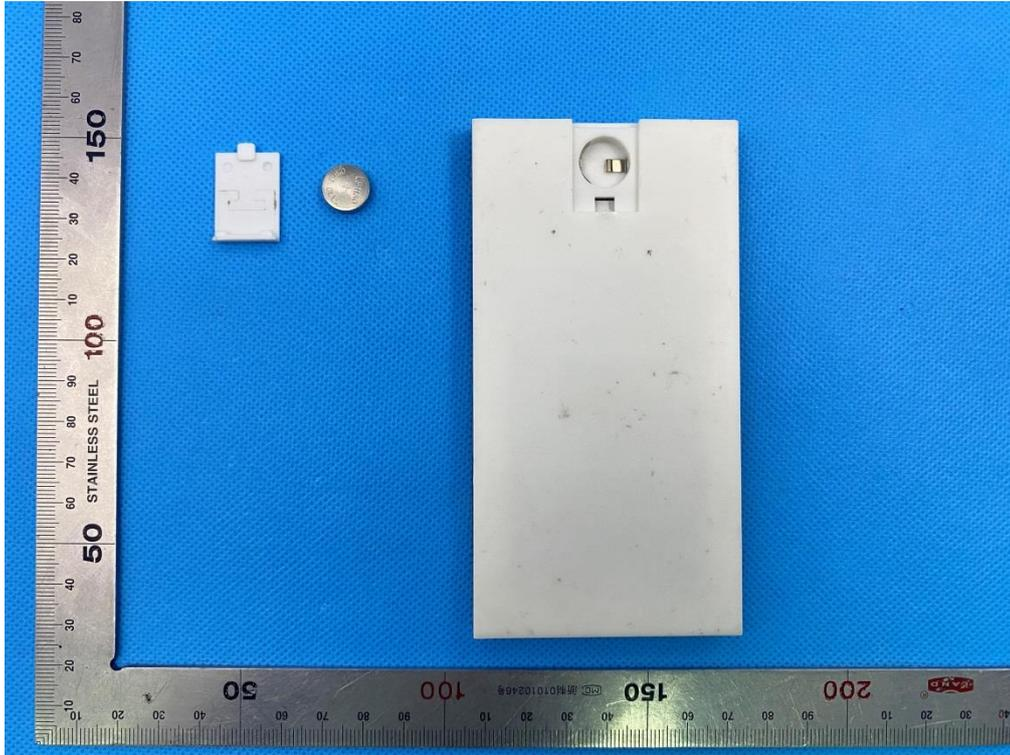

OPEN VIEW OF EUT-2



Any report having not been signed by authorized approver, or having been altered without authorization, or having not been stamped by the "Dedicated Testing/Inspection Stamp" is deemed to be invalid. Copying or excerpting portion of, or altering the content of the report is not permitted without the written authorization of AGC. The test results presented in the report apply only to the tested sample. Any objections to report issued by AGC should be submitted to AGC within 15days after the issuance of the test report. Further enquiry of validity or verification of the test report should be addressed to AGC by agc01@agccert.com.

OPEN VIEW OF EUT-3

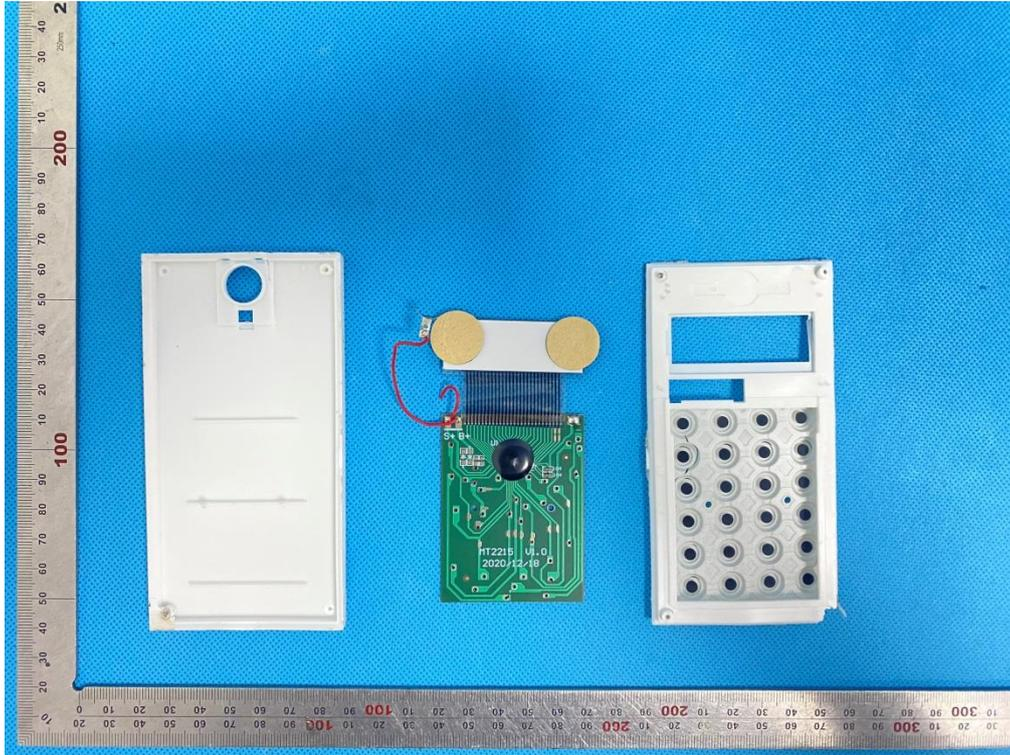

INTERNAL VIEW OF EUT-1

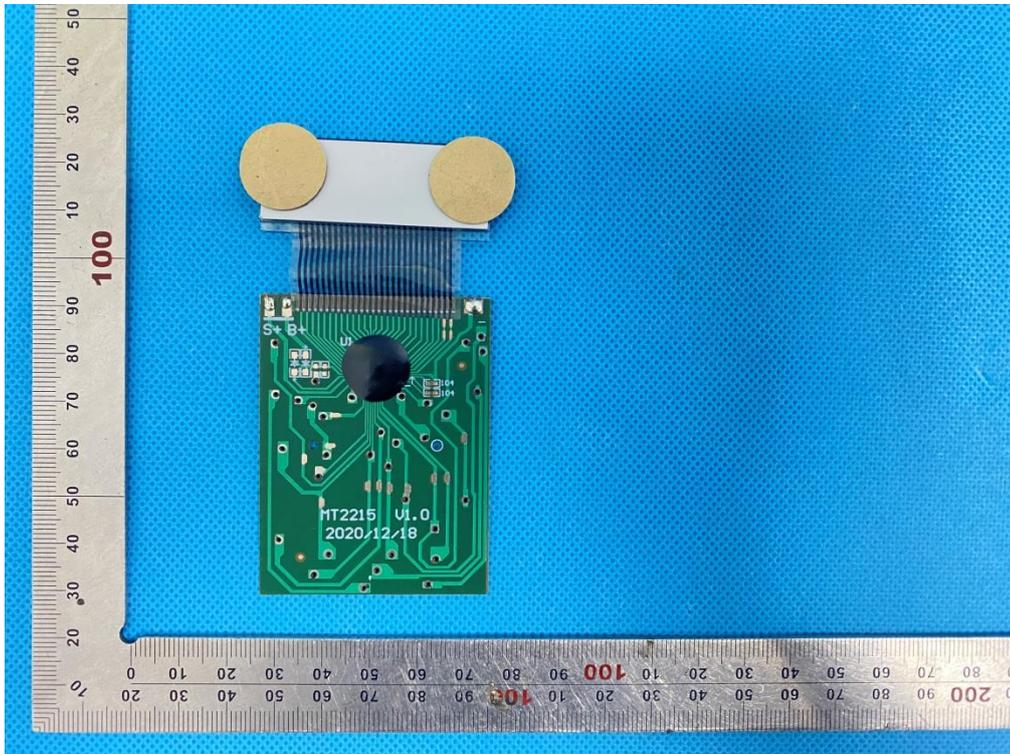

Any report having not been signed by authorized approver, or having been altered without authorization, or having not been stamped by the "Dedicated Testing/Inspection Stamp" is deemed to be invalid. Copying or excerpting portion of, or altering the content of the report is not permitted without the written authorization of AGC. The test results presented in the report apply only to the tested sample. Any objections to report issued by AGC should be submitted to AGC within 15days after the issuance of the test report. Further enquiry of validity or verification of the test report should be addressed to AGC by agc01@agccert.com.

INTERNAL VIEW OF EUT-2

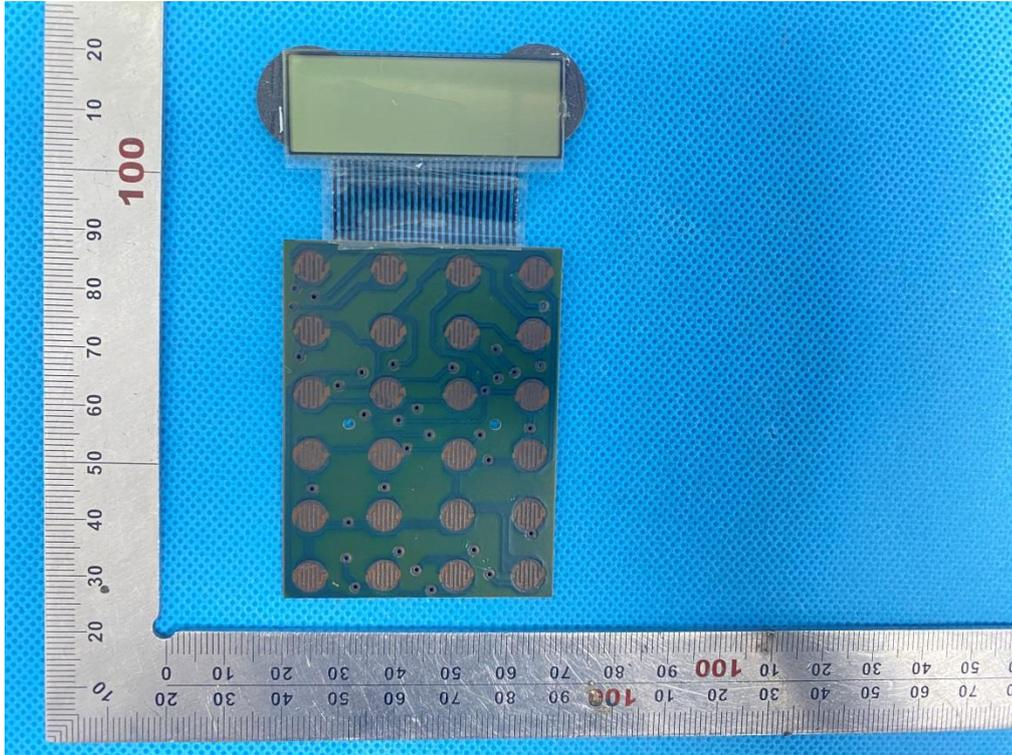

----END OF REPORT----

Any report having not been signed by authorized approver, or having been altered without authorization, or having not been stamped by the "Dedicated Testing/Inspection Stamp" is deemed to be invalid. Copying or excerpting portion of, or altering the content of the report is not permitted without the written authorization of AGC. The test results presented in the report apply only to the tested sample. Any objections to report issued by AGC should be submitted to AGC within 15days after the issuance of the test report. Further enquiry of validity or verification of the test report should be addressed to AGC by agc01@agccert.com.

Attestation of Global Compliance(Shenzhen)Co., Ltd
Attestation of Global Compliance(Shenzhen)Std & Tech Co., Ltd
Tel: +86-755 2523 4088 E-mail: agc@agccert.com Web: <http://www.agccert.com/>



Conditions of Issuance of Test Reports

1. All samples and goods are accepted by the Attestation of Global Compliance (Shenzhen) Co., Ltd (the “Company”) solely for testing and reporting in accordance with the following terms and conditions. The company provides its services on the basis that such terms and conditions constitute express agreement between the company and any person, firm or company requesting its services (the “Clients”).
2. Any report issued by Company as a result of this application for testing services (the “Report”) shall be issued in confidence to the Clients and the Report will be strictly treated as such by the Company. It may not be reproduced either in its entirety or in part and it may not be used for advertising or other unauthorized purposes without the written consent of the Company. The Clients to whom the Report is issued may, however, show or send it, or a certified copy thereof prepared by the Company to its customer, supplier or other persons directly concerned. The Company will not, without the consent of the Clients, enter into any discussion or correspondence with any third party concerning the contents of the Report, unless required by the relevant governmental authorities, laws or court orders.
3. The Company shall not be called or be liable to be called to give evidence or testimony on the Report in a court of law without its prior written consent, unless required by the relevant governmental authorities, laws or court orders.
4. In the event of the improper use of the report as determined by the Company, the Company reserves the right to withdraw it, and to adopt any other additional remedies which may be appropriate.
5. Samples submitted for testing are accepted on the understanding that the Report issued cannot form the basis of, or be the instrument for, any legal action against the Company.
6. The Company will not be liable for or accept responsibility for any loss or damage however arising from the use of information contained in any of its Reports or in any communication whatsoever about its said tests or investigations.
7. Clients wishing to use the Report in court proceedings or arbitration shall inform the Company to that effect prior to submitting the sample for testing.
8. The Company is not responsible for recalling the electronic version of the original report when any revision is made to them. The Client assumes the responsibility to providing the revised version to any interested party who uses them.
9. Subject to the variable length of retention time for test data and report stored hereinto as otherwise specifically required by individual accreditation authorities, the Company will only keep the supporting test data and information of the test report for a period of six years. The data and information will be disposed of after the aforementioned retention period has elapsed. Under no circumstances shall we provide any data and information which has been disposed of after retention period. Under no circumstances shall we be liable for damage of any kind, including (but not limited to) compensatory damages, lost profits, lost data, or any form of special, incidental, indirect, consequential or punitive damages of any kind, whether based on breach of contract of warranty, tort (including negligence), product liability or otherwise, even if we are informed in advance of the possibility of such damages.

Any report having not been signed by authorized approver, or having been altered without authorization, or having not been stamped by the “Dedicated Testing/Inspection Stamp” is deemed to be invalid. Copying or excerpting portion of, or altering the content of the report is not permitted without the written authorization of AGC. The test results presented in the report apply only to the tested sample. Any objections to report issued by AGC should be submitted to AGC within 15days after the issuance of the test report. Further enquiry of validity or verification of the test report should be addressed to AGC by agc01@agccert.com.